

節亮康復產品有限公司產品手冊

Health Product

Your Smart Health Care Solution Partners
Health care product | Smart home care | Air purification

Nursing Products

Z13

Ziglite Smart Health Care Products Co., Ltd.





Z IGLITE[®]
HEALTHCARE



Company Profile

公司簡介

ABOUT US 關於我們

Ziglite Smart Health Care Products Co., Ltd. Incorporated in 2018, we work with our partners to bring their products to the local market. Mainly engaged in the management of health care products, the main customers are hospitals and clinics, homes for the elderly and home patients.

We are committed to the development of excellent health care products, dedicated to the needs of a wide range of different customers, get the best care in the family treatment process, and greatly improve the effect of rehabilitation. Get the best care during the family treatment process and greatly improve the healing effect. We will provide quality products with stable quality and stable performance for customers.

We specialize in a wide range of products including: anti-virus and air freshening, incontinence care, mobility aids, decompression supplies, etc.

what's inside...

PRODUCT CATALOG

公司於2018年成立，我們與合作夥伴一起把他們的產品推向本地市場。以經營康護用品為主，主要客戶為醫院及診所，安老院及家居病人等。

我們致力於發展卓越的康護醫療產品，竭誠照顧廣大不同客戶的需要，在家庭治療過程中得到最好的護理，大大提高康復治療效果。在家庭治療過程中得到最好的護理，大大提高康復治療效果。務求為客戶提供品質優越及性能穩定的醫療產品。

我們專營的產品種類繁多，包括：抗病毒及空氣清新，失禁護理，助行用品，減壓用品等。



Limb Fixation 肢體固定



NAR P02



NAE P03



NDF P04



NAP P05



NAQ P06



NBC P07



NBD P08



NES P09



NFA P10



NFB P11



NDU P12

Flipping Pad 翻身轉移墊



NAF P14

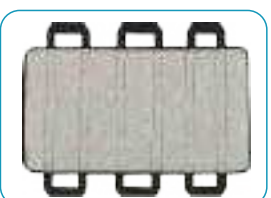

NBX P15



NAC P16

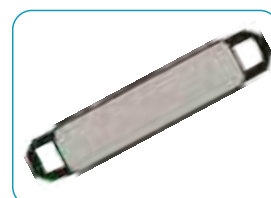

NBX2 P17



NER P18



NEU P19



NEV P20



NDV P21



NEG P22



NAX P23



NAX2 P24

Incontinence Nursing 失禁護理



NBI P26



NAA P27



NAS P28



NEH P29



P30



NAZ P31



NCE P32

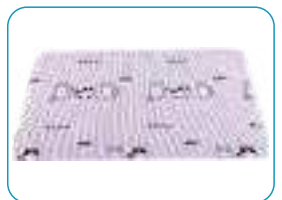

NCF P33



NFP P34



NFL P35



NFN P36



NFR P37



NFO P38

Life Nursing 生活護理



NAD P40



NBE P41



NBY2 P42



NAB P43



NDA P44



NBF P45



NDK P46



NDI P47



NDM P48



NDJ P49



NDP P50



WBF P51



NBB P52



NFC P53



NAH P54



NBV P55



NBU P56



NBP P57



NBA P58



NBN P59



NBO P60



NFD P61



NFE P62



NEY P63



NEZ P64



NEC P65



NEA P66



NEB P67



NEI P68



NEJ P69



NEO P70



NEP P71



NEQ P72



NFH P73



NFI P74



NFK P75



NCD P76



NDH P77



NET P78

Medical Tools 醫用工具



NDC P80



NDG P81



NDQ P82



NDR P83



NDS P84



NDT P85



NEL P86



NED P87



NEE P88



NEF P89

Limb Fixation

肢體固定

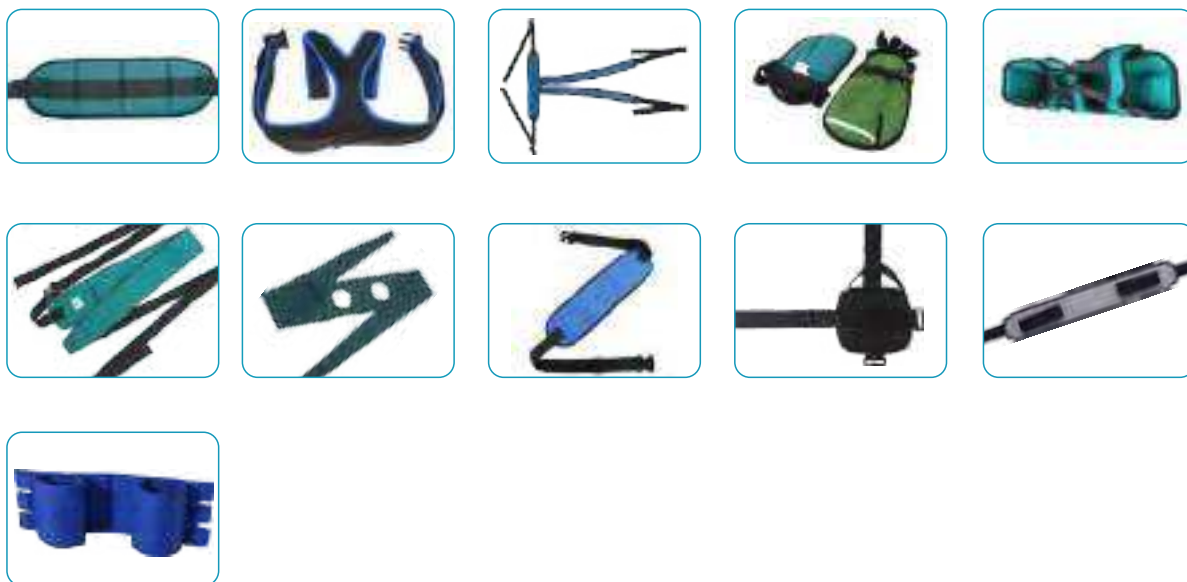

Medical Wheelchair Safety Strap

醫用輪椅安全固定帶

Model: NAR

Features:

- Curved appearance design, sturdy internal structure, self-locking to prevent the webbing from slipping off
- Comfortable, breathable, moisture-absorbing, heat-resistant, durable, clean-resistant, soft and smooth, firm and strong
- Filled with sponge, no mark, no restraint
- Precise tailoring, workmanship, ergonomic principles, and physiological characteristics
- Applicable crowd: people who need to be fixed in wheelchairs
- 弧形外觀設計，內部結構堅固，自鎖防止織帶滑落
- 舒適、透氣、吸濕、耐熱、耐用、耐清潔、柔軟光滑、牢固
- 填塞海綿，無痕迹，無束縛
- 精確的剪裁、工藝、人體工程學原理和生理特性
- 適用人群：坐輪椅需要固定的人士

Specifications

Product Model 產品型號	NAR
Product Material 產品材質	high elastic sponge 高彈力海綿
Product Function 產品功能	prevent patients from leaning forward and falling down 預防患者前傾、跌倒
Product Size 產品尺碼	one size 均碼
Color 顏色	green 綠
Product Size 產品尺寸	18*29*5cm
Product Weight 產品重量	325g
Package Size 包裝尺寸	30*21.5*5cm
Packing Weight 包裝重量	0.45kg



Instructions

◆ 把輪椅安全帶放置在病人胸前，織帶從病人腋下穿過至輪椅後方，把插扣扣上即可

注意事項：

- ◆ 此款為棉質產品請遠離火源或高溫環境。以免造成產品損壞，以防影響使用壽命
- ◆ 遠離潮濕環境，以免滋生細菌
- ◆ 嚴格避免與鋒利、尖銳的物體及腐蝕性溶液接觸
- ◆ 在固定時請注意鬆緊，以免固定太緊或太鬆造成不必要的傷害

Elastic Fixed Wheelchair Safety Belt

彈性固定輪椅安全帶

Model: NAE

Features:

- Velvet perforated and breathable mesh fabric does not hurt the skin
- The shoulder strap is made of elastic OK cloth, which effectively cushions the danger of bumps
- It adopts snap-on connection and can be adjusted
- The shoulders are fixed by Velcro, and the elasticity can be adjusted
- Purpose: Prevent the patient from tilting and falling over
- Applicable crowd: people who need to be fixed in wheelchairs
- 天鵝絨打孔透氣網布, 不傷皮膚
- 肩帶採用彈性OK布, 有效緩衝顛簸時產生的衝擊力
- 採用卡扣式連接, 可調節
- 雙肩採用魔术貼固定, 可調節鬆緊
- 用途: 防止病人傾斜翻到和摔跤
- 適用人群: 坐輪椅需要固定的人士



腰圍90-150cm

Specifications

Product Model 產品型號	NAE
Product Material 產品材質	velvet perforated cloth + OK cloth 天鵝絨孔布+OK布
Product Function 產品功能	anti dumping 防傾倒
Specifications 規格	average code adjustable 均碼可調節
Product Color 產品顏色	blue+black 藍+黑
Waist Size 腰圍尺寸	90-150cm
Storage Size 收納尺寸	16*10*10cm
Product Weight 產品重量	176g
Package Size 包裝尺寸	20*10*10cm
Packing Weight 包裝重量	0.23kg

Instructions

- ◆ 將腰帶從前面繞過輪椅, 在輪椅後面扣好, 調節鬆緊
- ◆ 將肩帶沿著雙肩穿過輪椅推手返回來粘貼好即可

注意事項:

- ◆ 請遠離火源或高溫環境, 以免造成產品損壞, 防止影響使用壽命
- ◆ 請遠離潮濕環境, 以免滋生細菌
- ◆ 可用清水和洗滌劑清洗, 不要用腐蝕性液體等

Wheelchair Safety Restraint Belt

輪椅安全約束帶

Model: NDF

Features:

- Sewed with thick nylon thread, the cross fixing is more solid
- Thickened fastener, safe use of quality
- Encrypted nylon webbing, strong security

- 加粗尼龍線縫製, 十字固定更結實
- 加厚扣具, 品質放心使用
- 加密尼龍織帶, 安全性強

Specifications

Product Model 產品型號	NDF
Product Material 產品材質	breathable mesh 透氣網
Product Function 產品功能	prevent patients from leaning forward and falling down 預防患者前傾、跌倒
Product Size 產品尺碼	one size 均碼
Color 顏色	blue 藍色
Product Size 產品尺寸	腰部:長約180cm,襠部:長約115cm waist length: ≈180cm crotch length: ≈115cm
Product Weight 產品重量	180g
Package Size 包裝尺寸	25*17*5cm
Packing Weight 包裝重量	0.26kg

腰部:長約180cm



襠部:長約115cm



Instructions

- ◆ 準備好約束帶
- ◆ 然後把綁帶串到椅子上, 扣上安全扣, 可根據個人使用調節長度
- ◆ 將綁帶串過大腿繞至椅子背部, 扣上安全扣, 可根據個人使用調節長度

注意事項:

- ◆ 此款為棉質產品請遠離火源或高溫環境。以免造成產品損壞, 以防影響使用壽命
- ◆ 遠離潮濕環境, 以免滋生細菌
- ◆ 嚴格避免與鋒利、尖銳的物體及腐蝕性溶液接觸
- ◆ 在固定時請注意鬆緊, 以免固定太緊或太鬆造成不必要的傷害

Fixed Gloves For Limb Rehabilitation

肢體復康固定手套

Model: NAP

Features:

- Breathable mesh, elastic rubber sheet, four-layer flannel, good comfort
- Adding cotton soft pads to make the wrist pressure filling and decompression, avoiding damage to the hands
- The zipper opening design is conducive to clinical nurses to observe the user's situation and is used for the detection of blood oxygen saturation
- Applicable population: suitable for patients who are confused, irritable, and have self-harm behavior
- 吸濕柔軟透氣網布, 彈性膠板, 四層絨布, 舒適度好
- 加棉軟墊使腕部受力填充減壓, 避免綁帶給皮膚帶來傷害
- 拉鏈開口設計, 可以當封口使用利於臨床護士觀察使用者情況, 用於血氧飽和度的檢測
- 適用人群: 適用神志模糊、煩躁不安、有自傷行為治療性的病人, 為虛弱無力患者保護手部組織損傷固定



Specifications

Product Model 產品型號	NAP
Product Material 產品材質	mesh / cushion coated rubber sheet 網布/軟墊裹覆膠板
Product Function 產品功能	protect hands from injury 保護手部損傷
Wrist Width 手腕寬度	約24-35cm
Palm Width 手掌寬度	約15cm
Product Size 產品尺碼	m 中號
Color 顏色	green 綠
Product Size 產品尺寸	18*29*5cm
Product Weight 產品重量	325g
Package Size 包裝尺寸	30*21.5*5cm
Packing Weight 包裝重量	0.45kg

Instructions

◆ 手部套進手套, 固定腕部, 再用綁帶固定到床上或者輪椅等其他支撐物上

注意事項:

- ◆ 嚴格避免與鋒利、尖銳的物體及腐蝕性溶液接觸
- ◆ 為避免交叉感染, 約束手套不可在病人間交叉使用, 並定期對約束手套進行清洗和消毒
- ◆ 使用前檢查約束手套各個部位是否牢固, 有無破損等
- ◆ 用含氯消毒液清洗浸泡時間不得超過30分鐘
- ◆ 每拉伸固定2小時請適當的休息15-30分鐘

Ankle Rehabilitation Fixed Protective Cover

踝關節復康固定保護套

Model: NAQ

Features:

- Adjustable traction belt, can adjust the back bending angle, adjust the comfort angle
- Multiple Velcro design, stable and easy to wear
- Built in fixation plate can effectively support the lower leg, which is stable and comfortable to use
- Built in decompression cotton, built-in protruding sponge in ankle joint, comfortable and strong wrapping
- Applicable crowd: long-term bedridden, lack of lower limb movement, sign of foot drop, elderly and weak
- 可調牽引帶，能調節背曲角度，調整舒適角
- 多條魔术貼設計，固定穩固，且方便穿戴
- 內置固定板，有效支撐小腿，使用穩固、舒適
- 內置減壓棉，踝關節內置凸出海綿，且舒適，包裹性強
- 適用人群：長期臥床病人、下肢缺乏運動的病人、足下垂先兆的病人、年老體弱者



Specifications

Product Model 產品型號	NAQ
Product Material 產品材質	high elastic sponge,twillcotton 高彈力海綿、斜紋棉布
Product Function 產品功能	prevention of lower extremity venous thrombosis 預防下肢靜脈血栓
Product Specifications 產品規格	right and left 左右通用
Product Size 產品尺碼	one size 均碼
Color 顏色	green 綠
Product Size 產品尺寸	40*26*4cm
Product Weight 產品重量	340g
Package Size 包裝尺寸	42*27*21cm
Packing Weight 包裝重量	0.78kg

Instructions

- ◆ 腳套進去，貼上魔术貼，拉緊釦帶即可固定

注意事項：

- ◆ 此款為棉質產品請遠離火源或高溫環境。以免造成產品損壞，以防影響使用壽命
- ◆ 遠離潮濕環境，以免滋生細菌
- ◆ 嚴格避免與鋒利、尖銳的物體及腐蝕性溶液接觸
- ◆ 每拉伸固定2小時請適當的休息15-30分鐘

Adjustable Restraining Belt

可調約束帶安全帶

Model: NBC

Features:

- Prevent from getting up, falling off the bed and rollover. You can turn left and right, and there is room for activity
- Multi purpose bed, wheelchair and can be used
- Polyester cotton material, breathable and comfortable, widened and thickened design, edging technology, firm and durable
- Adjustable length, more convenient to use
- Applicable population: Alzheimer's disease, people in need of restraint and protection, etc
- 防止起身、墜床、側翻可以左右翻身, 有活動空間
- 集多用途於一身床、輪椅、都能使用
- 滌棉材質、透氣舒適, 加寬加厚設計, 包邊工藝, 牢固耐用
- 可調節長度, 使用更方便
- 適用人群: 老年癡呆、需要約束防護等人群



Specifications

Product Model 產品型號	NBC
Product Material 產品材質	polyester cotton + nylon 滌棉+尼龍
Product Function 產品功能	fixed restraint and safety belt 固定約束、安全帶
Product Size 產品尺碼	suitable for bed width within 1.5m 適合1.5M以內床寬
Color 顏色	green 綠
Product Size 產品尺寸	440*14*2cm
Product Weight 產品重量	485g
Package Size 包裝尺寸	25.5*20*7cm
Packing Weight 包裝重量	0.612kg

Instructions

- ◆ 準備好約束帶
- ◆ 產品一頭從開口處穿進去
- ◆ 然後把綁帶串到床下或者輪椅上, 扣上安全扣, 可根據個人使用調節長度
- ◆ 固定好後即可開始使用
- ◆ 前面穿孔法, 不想轉身: 穿孔放在身體上方就不能轉身
- ◆ 後背穿孔法, 想轉身: 穿孔放在身下就可以轉身

注意事項:

- ◆ 此款為棉質產品請遠離火源或高溫環境, 以免造成產品損壞, 以防影響使用壽命
- ◆ 遠離潮濕環境, 以免滋生細菌

Restless Patient's Leg About Fixed Belt

躁動病人腿部約固定帶

Model: NBD

Features:

- Polyester cotton material binding belt, strong and durable polyester cotton, will not have a sense of oppression
 - Easy to wear, two-step one-time, fast operation
 - Body washing is convenient and simple
 - Product function: prevent self injury caused by unconsciousness or agitation of bedridden persons
 - Applicable to: people in need of postoperative rehabilitation, agitation, mental patients, drug addicts, etc
-
- 滌棉材質約束帶，堅固耐用滌棉，不會有壓迫感
 - 穿戴方便簡單，二步一次搞定，操作快捷
 - 體水洗，方便簡單
 - 產品作用：防止臥床者無意識或者躁動引起的自傷
 - 適用於：術後康復、躁動、精神患者、戒毒人員等需要適用人群束縛人群

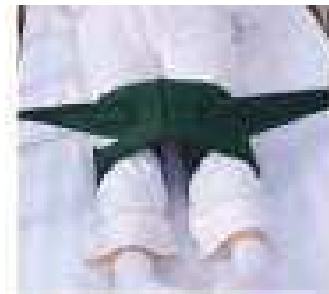

Specifications

Product Model 產品型號	NBD
Product Material 產品材質	polyester cotton 滌棉
Product Function 產品功能	anti dumping 肢體固定
Spec 規格	average code adjustable 均碼可調節
Product Color 產品顏色	dark green 墨綠
Product Size 孔內徑約	10cm
Product Size 產品尺寸	325*23*2cm
Product Weight 產品重量	435g
Package Size 包裝尺寸	25.5*20*7cm
Packing Weight 包裝重量	0.545kg

Instructions

- ◆ 將產品取出後從放在膝蓋處從上向下纏繞
- ◆ 然後將兩邊帶子從膝蓋內側繞過來穿過圓孔然後兩邊拉緊固定在床邊扶手或者床沿處即可

注意事項：

- ◆ 此款為棉質產品請遠離火源或高溫環境，以免造成產品損壞，以防影響使用壽命
- ◆ 遠離潮濕環境，以免滋生細菌

Wheelchair Fixing Strap

輪椅防滑固定帶

Model: NES

Features:

- Insert buckle design, securely fastened, sturdy and durable
 - Adjustable buckle design, adjustable length, convenient for portability but not limited to people
 - Breathable mesh, comfortable to wear, durable and long-lasting
 - Weaving tape is resistant to pulling, abrasion, and scraping
- 插扣設計, 牢牢扣住, 牢固耐用
 - 調節扣設計, 可調長度, 方便攜帶不勒人
 - 透氣網格, 佩戴舒適, 經久耐用
 - 織帶耐拉耐扯, 耐磨耐刮



Specifications

Product Model 產品型號	NES
Product Material 產品材質	sandwich mesh+nylon strap 三文治網布+尼龍綁帶
Product Function 產品功能	fixed restraint and safety belt 固定約束、安全帶
Product Size 產品尺寸	44*12cm 單邊繩長:50cm
Product Weight 產品重量	86g
Package Size 包裝尺寸	12*12*5cm
Packing Weight 包裝重量	0.12kg

Instructions

◆ 把輪椅安全帶放置在病人胸前, 織帶從病人腋下穿過至輪椅後方, 把插扣扣上即可

注意事項:

- ◆ 此款為棉質產品請遠離火源或高溫環境, 以免造成產品損壞, 以防影響使用壽命
- ◆ 遠離潮濕環境, 以免滋生細菌
- ◆ 在固定時請注意鬆緊, 以免固定太緊或太松造成不必要的傷害

Wheelchair Foot Restraint Belt

輪椅腳部約束帶

Model: NFA

Features:

- The cross fixation is very firm, and the length of the webbing can be adjusted, suitable for all wheelchairs
 - The length can be adjusted freely, and can be used by both adults and children. The elastic design ensures good fixation effect
 - Encrypted nylon webbing, sturdy and reusable, thickened link buckle, resistant to high and low temperatures
 - Suitable for patients in wheelchairs, fix feet on pedals to prevent slipping
- 十字固定很牢固，織帶長度可以調節，適合所有的輪椅
 - 長度隨意調，大人小孩都能使用，鬆緊設計，固定效果好不勒腳
 - 加密尼龍織帶，結實可以反復使用，加厚鏈接扣，耐高溫和耐低溫
 - 適合坐輪椅的病人，把腳固定踏板上，防止滑落



Specifications

Product Model 產品型號	NFA
Product Material 產品材質	oxford 牛津布
Product Function 產品功能	foot fixation 腳部固定
Spec 規格	1 pair
Product Size 產品尺寸	16*14cm Single
Product Weight 產品重量	162g
Package Size 包裝尺寸	25*17*5cm
Packing Weight 包裝重量	0.227kg

Instructions

◆ 取出產品，打開底部魔术貼套住輪椅腳踏板將魔术貼貼好固定

注意事項：

- ◆ 此款為棉質產品請遠離火源或高溫環境，以免造成產品損壞，以防影響使用壽命
- ◆ 遠離潮濕環境，以免滋生細菌

Wheelchair Leg Restraint Belt

輪椅腿部約束帶

Model: NFB

Features:

- Wide and elastic legs, suitable for both fat and thin, spacious, soft, comfortable and skin friendly
- Elastic+widened Velcro, adjustable in size, comfortable without leg strain
- Thickened pure cotton canvas, sturdy and breathable
- 腿部加寬鬆緊, 胖瘦都能用, 寬大柔軟舒服親膚
- 鬆緊+加寬魔术貼, 鬆緊尺寸隨便調, 舒服不勒腿
- 加厚純棉帆布, 結實透氣



Specifications

Product Model 產品型號	NFB
Product Material 產品材質	canvas 帆布
Product Function 產品功能	fixed constraints 固定約束
Product Size 產品尺寸	70*10cm 單邊繩長:12cm
Leg Circumference Size 腿圍尺寸	40cm
Product Weight 產品重量	120g
Package Size 包裝尺寸	20.3*11*3.5cm
Packing Weight 包裝重量	0.157kg

Instructions

◆取出產品, 根據自己的需求調節大小, 粘上魔术貼即可

注意事項:

- ◆此款為棉質產品請遠離火源或高溫環境, 以免造成產品損壞, 以防影響使用壽命
- ◆遠離潮濕環境, 以免滋生細菌
- ◆在固定時請注意鬆緊, 以免固定太緊或太松造成不必要的傷害

Wheelchair Foot Restraint Belt

輪椅腳部約束帶

Model: NDU

Features:

- The cross fixation is very firm, and the length of the webbing can be adjusted, suitable for all wheelchairs
 - The length can be adjusted freely, and can be used by both adults and children. The elastic design ensures good fixation effect
 - Encrypted nylon webbing, sturdy and reusable, thickened link buckle, resistant to high and low temperatures
 - Suitable for patients in wheelchairs, fix feet on pedals to prevent slipping
- 十字固定很牢固，織帶長度可以調節，適合所有的輪椅
 - 長度隨意調，大人小孩都能使用，鬆緊設計，固定效果好不勒腳
 - 加密尼龍織帶，結實可以反復使用，加厚鏈接扣，耐高溫和耐低溫
 - 適合坐輪椅的病人，把腳固定踏板上，防止滑落

Specifications

Product Model 產品型號	NDU
Product Material 產品材質	oxford 滌棉
Product Function 產品功能	foot fixation 腳部固定
Product Size 產品尺寸	80*16cm
Product Weight 產品重量	205g
Package Size 包裝尺寸	25*17*5cm
Packing Weight 包裝重量	0.27kg



Instructions

◆ 取出產品，打開底部魔术貼套住輪椅腳踏板將魔术貼貼好固定

注意事項：

- ◆ 此款為棉質產品請遠離火源或高溫環境，以免造成產品損壞，以防影響使用壽命
- ◆ 遠離潮濕環境，以免滋生細菌

材質：滌棉
顏色：藍色
產品尺寸：80*16cm
淨重：205g
包裝尺寸：25*17*5cm-B10
毛重：0.27kg



Flipping Pad

翻身轉移墊



Anti Bedsores Displacement Diaphragmatic Pad

防褥瘡移位隔尿墊

Model: NAF

Features:

- 8 handbags for easy multi-directional movement
- Multi purpose, turn over Pad + urine pad in one
- Oxford cloth is used, which is strong, practical and not easy to break
- Absorbent sponge is used inside to prevent incontinence
- Easy to store and clean
- Suitable for people with mobility difficulties, long-term bedridden and disabled
- 8條手提袋, 方便多方位移動
- 一帶多用, 翻身墊+尿墊合一
- 採用牛津布, 受力度大、實用、不易斷裂
- 內裡採用吸水海綿, 防止失禁尿液
- 易於收納, 清潔方便
- 適用於行動不便、長期臥床、殘障人士



Specifications

Product Model 產品型號	NAF
Product Material 產品材質	waterproof oxford cloth 防水牛津布
Product Function 產品功能	turning over, shifting, urination 翻身、移位、隔尿
Specifications 規格	average code 均碼
Product Color 產品顏色	blue+black 藍+黑
Product Size 產品尺寸	120*72*3cm
Product Weight 產品重量	687g
Package Size 包裝收納尺寸	26.5*19*16cm
Packing Weight 包裝重量	0.81kg

Instructions

- ◆ 將產品取出放置於床上讓病人躺在上面即可
- ◆ 需要移床時抓住手提位移動即可

注意事項:

- ◆ 請遠離火源或高溫環境; 以免造成產品損壞, 影響使用壽命
- ◆ 遠離潮濕環境, 以免滋生細菌
- ◆ 可用清水和洗滌劑清洗, 不要用腐蝕性液體等

Waterproof Rollover and Transfer Pad

防水翻身移位墊

Model: NBX

Features:

- Single operation, convenient and labor-saving, no waist injury, flexible use
- Transfer and roll over easily, comfortable and labor-saving
- Urine-proof and water-proof, assisted to roll over, TPU waterproof cloth on the back, effective waterproof and anti-urine
- Applicable to: people with mobility difficulties, long-term bedridden, and disabled
- 單人操作, 方便省力, 不傷腰身, 使用靈活
- 轉移翻身, 輕鬆翻身, 舒適省力
- 隔尿防水, 輔助翻身, 背面為TPU隔水布, 有效防水防尿
- 適用於: 行動不便、長期臥床、殘障人士

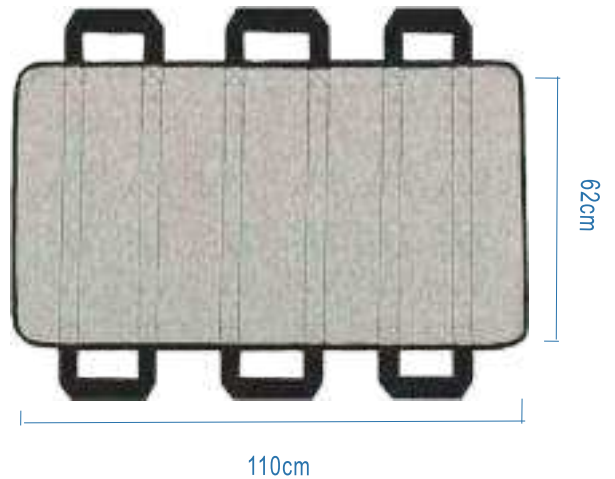

Specifications

Product Model 產品型號	NBX
Product Material 產品材質	cotton+tpu waterproof layer 純棉+TPU防水層
Product Function 產品功能	turning over, shifting, urination 翻身、移位、隔尿
Product Color 產品顏色	grey 灰色
Bearing 承重	< 100 kg
Product Size 產品尺寸	110*62cm
Product Weight 產品重量	778g

Instructions

- ◆ 將產品取出放置於床上讓病人躺在上面即可
- ◆ 需要移床時抓住手提位移動即可

注意事項:

- ◆ 請遠離火源或高溫環境; 以免造成產品損壞, 影響使用壽命
- ◆ 遠離潮濕環境, 以免滋生細菌
- ◆ 可用清水和洗滌劑清洗, 不要用腐蝕性液體等

Turn Over Nursing Belt

翻身護理帶

Model: NAC

Features:

- Suitable for home care and help patients with heavier weight
- The operation is more convenient, and it can be operated by turning around and pulling
- The turning angle can be changed at will, and the effect of anti-bedsores is better
- Use waterproof and anti-friction materials to reduce friction with the bed surface
- Suitable for: nursing, helping patients, assisting in changing diapers and clothes, etc
- 適合居家人手不足和臥床病人體重較重的使用
- 操作更方便, 左右翻身一拉就可操作
- 翻身角度可隨心變換, 防褥瘡效果更好
- 採用防水防摩擦材質, 減輕與床面摩擦力
- 適用於: 護理、幫助病人, 輔助換尿褲和衣服等



Specifications

Product Model 產品型號	NAC
Product Material 產品材質	oxford cloth + shredded milk 牛津布+牛奶絲
Product Function 產品功能	assisted roll over 輔助翻身
Product Bearing 產品承重	100kg
Product Size 產品尺寸	160*34*1cm
Product Weight 產品重量	300g
Package Size 包裝尺寸	30*21.5*5cm
Packing Weight 包裝重量	0.37kg

Instructions

- ◆ 將產品取出鋪開在床上或者從病人身體下麵穿過
- ◆ 將兩邊釦手處合攏, 用力往側邊或者坐立方向拉動即可
- ◆ 可以用產品將病人往側邊拉動, 然後粘貼固定在床邊扶手或者床沿處
- ◆ 可以放在腿部幫助腿部訓練等

注意事項:

- ◆ 遠離潮濕環境, 以免滋生細菌
- ◆ 請遠離火源或高溫環境; 以免造成產品損壞, 影響使用壽命
- ◆ 可用清水和洗滌劑清洗, 不要用腐蝕性液體等

Flip Over and Transfer Strap

翻身移位帶

Model: NBX2

Features:

- Single operation, convenient and labor-saving, no waist injury, flexible use
- Transfer and roll over easily, comfortable and labor-saving
- Suitable for: postoperative patients, people with stroke and hemiplegia, long-term bedridden patients and other inconvenient individuals
- 單人操作, 方便省力, 不傷腰身, 使用靈活
- 轉移翻身, 輕鬆翻身, 舒適省力
- 適用於: 術後病人、中風偏癱人群、長久臥床病人等不便人士

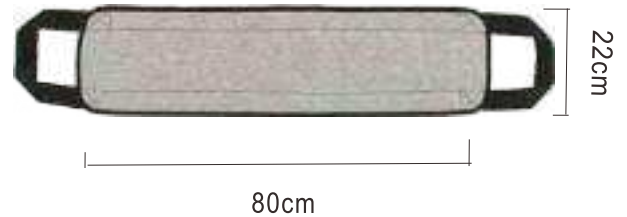

Specifications

Product Model 產品型號	NBX2
Product Material 產品材質	cotton+tpu waterproof layer 純棉+TPU防水層
Product Function 產品功能	turning over, shifting 翻身、移位
Product Color 產品顏色	grey 灰色
Bearing 承重	< 100 kg
Product Size 產品尺寸	80*22cm
Product Weight 產品重量	143g

Instructions

- ◆ 將產品取出放置於床上讓病人躺在上面即可
- ◆ 需要移床時抓住手提位移動即可

注意事項:

- ◆ 請遠離火源或高溫環境; 以免造成產品損壞, 影響使用壽命
- ◆ 遠離潮濕環境, 以免滋生細菌
- ◆ 可用清水和洗滌劑清洗, 不要用腐蝕性液體等

Flip Over and Transfer Strap

翻身移位帶

Model: **NER**

Features:

- Waterproof Oxford fabric is adopted, which can be washed, thickened and has high load-bearing
 - Grip design, more solid, not tight
 - Fine workmanship, fine sewing as a whole, long service life
 - Suitable for: nursing, helping patients, assisting in changing diapers and clothes, etc.
-
- 採用防滲水牛津布面料, 可水洗, 加厚材質, 承重高
 - 抓手設計, 更堅固, 不勒手
 - 精工細做, 整體採用細密縫製, 使用壽命長
 - 適用於: 護理、幫助病人, 輔助換尿褲和衣服等



Specifications

Product Model 產品型號	NER
Product Material 產品材質	waterproof oxford cloth 防水牛津布
Product Function 產品功能	assisted roll over 輔助翻身
Product Size 產品尺寸	25*80cm
Product Weight 產品重量	479g
Package Size 包裝尺寸	30*21.5*5cm

Instructions

- ◆ 將產品取出放置於床上讓病人躺在上面即可
- ◆ 需要移床時抓住手提位移動即可

注意事項:

- ◆ 遠離潮濕環境, 以免滋生細菌
- ◆ 請遠離火源或高溫環境; 以免造成產品損壞, 影響使用壽命
- ◆ 可用清水和洗滌劑清洗, 不要用腐蝕性液體等

Patient Transfer Belt

病人轉移帶

Model: NEU

Features:

- The transfer belt is made of nylon fabric and sandwich mesh fabric, built-in pearl cotton, more breathable and comfortable to wear
- Multiple uses and applications prevent the patient from being worn when moving the patient's skin
- Each side has three grip areas for patients of different weights
- Suitable for: postoperative patients, stroke patients with hemiplegia, long-term bed patients, etc
- 轉移帶採用尼龍面料和三明治網眼面料，內置珍珠棉，佩戴起來更加透氣舒適
- 多種用途和應用可防止患者在移動患者的皮膚時被磨損
- 每邊有3個可以抓握的地方，方便不同體重的病人使用
- 適用於：術後病人、中風偏癱人群、長久臥床病人等



Specifications

Product Model 產品型號	NEU
Product Material 產品材質	nylon, sandwich mesh fabric 尼龍, 三明治網眼面料
Product Function 產品功能	turning over, shifting 翻身、移位
Product Size 產品尺寸	121*18cm
Product Weight 產品重量	116g

Instructions

- ◆ 將產品取出放置於床上讓病人躺在上面即可
- ◆ 需要移床時抓住手提位移動即可

注意事項:

- ◆ 請遠離火源或高溫環境；以免造成產品損壞，影響使用壽命
- ◆ 遠離潮濕環境，以免滋生細菌
- ◆ 可用清水和洗滌劑清洗，不要用腐蝕性液體等

Flip Over and Transfer Pad

翻身搬運墊

Model: NEV

Features:

- It is made of water-proof Oxford fabric, which can be washed and thickened, and has high bearing capacity.
 - Double grip design, more solid, not tight.
 - Fine workmanship, fine sewing as a whole, long service life.
 - Suitable for: nursing, helping patients, and assisting in changing diapers and clothes.
-
- 採用防滲水牛津布面料, 可水洗, 加厚材質, 承重高
 - 雙抓手設計, 更堅固, 不勒手
 - 精工細做, 整體採用細密縫製, 使用壽命長
 - 適用於: 護理、幫助病人, 輔助換尿褲和衣服等



Specifications

Product Model 產品型號	NEV
Product Material 產品材質	waterproof oxford cloth 防水牛津布
Product Function 產品功能	assisted flipping and handling 輔助翻身 搬運
Bearing 承重	< 100 kg
Product Size 產品尺寸	108*68cm
Product Weight 產品重量	1185g

Instructions

- ◆ 將產品取出放置於床上讓病人躺在上面即可
- ◆ 需要移床時抓住手提位移動即可

注意事項:

- ◆ 遠離潮濕環境, 以免滋生細菌
- ◆ 請遠離火源或高溫環境; 以免造成產品損壞, 影響使用壽命
- ◆ 可用清水和洗滌劑清洗, 不要用腐蝕性液體等

Handling Gloves

搬運過床手套

Model: NDV

Features:

- Carefully designed small hooks on the arms, hang them on the wall without taking up space, and use them anytime
- Convenient storage, space saving, and reusable. Dirty products can be washed with soap in clean water and dried in the shade
- Applicable to: Assisting in transporting bedridden patients
- 手臂上貼心設計小小的掛勾, 將其掛在牆上, 不占地方, 隨取隨用
- 收納方便, 不占地方並可以重複使用, 弄髒的產品用肥皂在清水中洗
- 乾淨陰乾便可
- 適用於: 輔助搬運臥床病人



Specifications

Product Model 產品型號	NDV
Product Material 產品材質	nylon 尼龍
Product Function 產品功能	assist in turning over, shifting 輔助翻身、移位
Product Size 產品尺寸	55.5*22.5cm
Product Weight 產品重量	35g

Instructions

- ◆ 取出產品, 穿戴上後, 輕鬆插入病人身下, 幫助調整身體。

注意事項:

- ◆ 請勿使用金屬清潔球等尖銳物品進行清洗;
- ◆ 使用後請及時洗淨晾乾;
- ◆ 請勿長期置於高溫場所, 以免變形;
- ◆ 請勿接觸明火及腐蝕性液體。

Mobile Borrowing Force Cloth

移動借力滑布

Model: NEG

Features:

- Special fabric, non slip on the outer side and smooth on the inner side
- Convenient storage without taking up space
- Applicable to: auxiliary nursing for mobile bed rest patients

- 特殊面料, 外側防滑內側順滑
- 收納方便不占地方
- 適用於: 輔助護理移動臥床病人



Specifications

Product Model 產品型號	NEG
Product Material 產品材質	nylon 尼龍
Product Function 產品功能	assisted flipping and handling 輔助翻身 搬運
Product Size 產品尺寸	70*68cm
Product Weight 產品重量	64g

Instructions

- ◆ 將產品取出放置於床上讓病人躺在上面即可
- ◆ 需要移床時抓住手提位移動即可

注意事項:

- ◆ 遠離潮濕環境, 以免滋生細菌
- ◆ 請遠離火源或高溫環境; 以免造成產品損壞, 影響使用壽命
- ◆ 可用清水和洗滌劑清洗, 不要用腐蝕性液體等

Bed Turning Assistant

臥床翻身輔助器

Model: NAX

Features:

- Waterproof Pu fabric is adopted, which is waterproof, easy to take care of and easy to use
- High quality sponge lining, comfortable, soft, strong and durable
- Integrated zipper design, beautiful appearance, easy to disassemble and wash
- It can be stuck in a wheelchair to help patients unload their strength (not applicable for obese people)
- Applicable scenario: the assistant turns over and takes care when turning over. It can be fixed on the wheelchair to relieve the patient
- 採用防水PU面料, 防水易打理, 使用方便
- 優質海綿內裡, 舒適柔軟, 結實耐用
- 一體式拉鍊設計, 外形美觀, 方便拆洗
- 可卡在輪椅上, 幫忙患者卸力 (肥胖者不適用)
- 適用場景: 助理翻身以及翻身時進行護理, 可以固定在輪椅上讓患者卸力

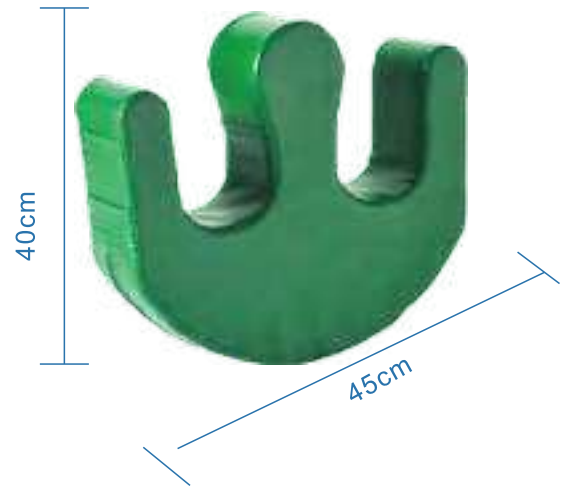

Specifications

Product Model 產品型號	NAX
Product Material 產品材質	PU leather + rebound cotton PU皮+回彈棉
Product Function 產品功能	roll over assist 翻身輔助
Color 顏色	green 綠色
Product Size 產品尺寸	42*39*12cm
Product Weight 產品重量	500g

Instructions

- ◆ 將墊子置於雙腿下方
- ◆ 放入後在雙腿中間立起
- ◆ 將患者雙手放於胸前
- ◆ 護理人員將墊子推動即可翻身

注意事項:

- ◆ 皮膚過敏者慎用
- ◆ 對產品材料過敏者慎用
- ◆ 應存放於乾燥和通風良好的室內, 勿於酸鹼等腐蝕性物質混放
- ◆ 遠離高熱、火源等環境
- ◆ 產品只可擦洗, 不可機洗

Bed Turning Assistant

臥床翻身輔助器

Model: NAX2

Features:

- Waterproof Pu fabric is adopted, which is waterproof, easy to take care of and easy to use
 - High quality sponge lining, comfortable, soft, strong and durable
 - Integrated zipper design, beautiful appearance, easy to disassemble and wash
 - It can be stuck in a wheelchair to help patients unload their strength (not applicable for obese people)
 - Applicable scenario: the assistant turns over and takes care when turning over. It can be fixed on the wheelchair to relieve the patient
-
- 採用防水PU面料, 防水易打理, 使用方便
 - 優質海綿內裡, 舒適柔軟, 結實耐用
 - 一體式拉鍊設計, 外形美觀, 方便拆洗
 - 可卡在輪椅上, 幫忙患者卸力 (肥胖者不適用)
 - 適用場景: 助理翻身以及翻身時進行護理, 可以固定在輪椅上讓患者卸力



Specifications

Product Model 產品型號	NAX2
Product Material 產品材質	PU leather + rebound cotton PU皮+回彈棉
Product Function 產品功能	roll over assist 翻身輔助
Color 顏色	blue 藍色
Product Size 產品尺寸	45*40*12cm
Product Weight 產品重量	550g

Instructions

- ◆ 將墊子置於雙腿下方
- ◆ 放入後在雙腿中間立起
- ◆ 將患者雙手放於胸前
- ◆ 護理人員將墊子推動即可翻身

注意事項:

- ◆ 皮膚過敏者慎用
- ◆ 對產品材料過敏者慎用
- ◆ 應存放於乾燥和通風良好的室內, 勿於酸鹼等腐蝕性物質混放
- ◆ 遠離高熱、火源等環境
- ◆ 產品只可擦洗, 不可機洗

Incontinence Nursing

失禁護理



Intelligent Urination Nursing Instrument

智能大小便護理儀

Model: NBI

Features:

- The carrier realizes the functions of automatic induction, collection, washing and drying
 - Ad hoc odor elimination function and noise elimination function
 - The special mattress can be used with the nursing bed to turn over, lift and drop legs, so as to breathe and keep warm and reduce the occurrence of bed sore
 - Applicable to: postoperative bedridden patients, disabled or paralyzed persons, bedridden elderly, etc
 - Application: family, nursing home, hospital, rehabilitation center, etc
- 自動感應、收集、沖洗、烘乾功能實現的載體
 - 特設的消除臭味功能,消除噪音功能
 - 專用床墊,可配合護理床實現翻身、起身抬腿、落腿等,透氣、保暖,減少褥瘡的發生
 - 適用於:術後臥床病人、傷殘或癱瘓人士、臥床老人等
 - 應用於:家庭、養老院、醫院、康復中心等

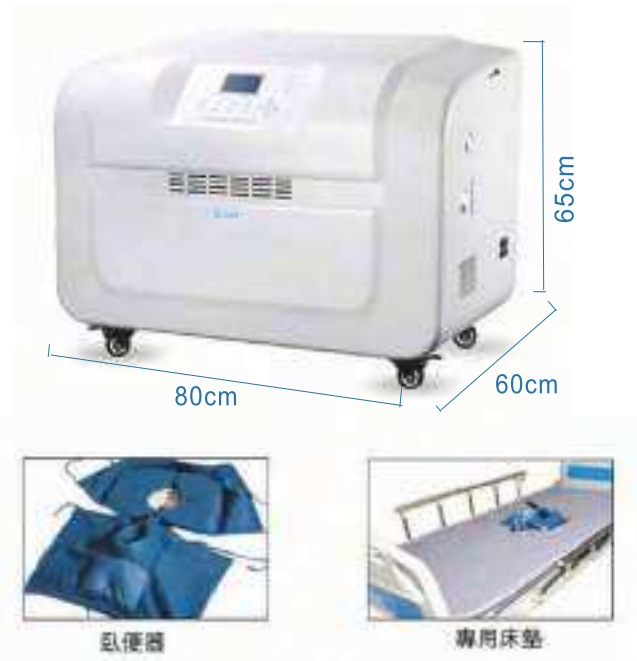

Specifications

Product Model 產品型號	NBI
Product Material 產品材質	plastic + cotton cloth + brown pad + sponge 塑膠+棉布+棕墊+海綿
Product Function 產品功能	bed rest defecation care 臥床大小便護理
Water Tank Capacity 水箱容量	clean water bucket: 6000ml, dirty water bucket: 7000ml 清水桶:6000ml, 污水桶:7000ml
Negative Pressure 負壓	urine negative pressure: 1-3, stool negative pressure: 3-5 小便負壓:1-3檔,大便負壓:3-5檔
Working Mode 模式選擇	automatic or manual 自動或手動
Flushing Water Temperature 沖洗水溫	34-39 °C
Drying Temperature 烘乾氣溫	40-55 °C
Host Size 主機尺寸	80*60*65cm
Host Weight 主機重量	35kg

Instructions



產品概述:當使用者排出大小便時,儀器的臥便器自動感知,主機立即啟動抽取大小便並存儲在汙物桶內,大小便結束後,潔淨的溫水自動噴出,沖洗使用者的隱私部位和集便器內部,沖洗後立即進行暖風烘乾。

Medical silicone urine connector

醫用矽膠接尿器

Model: NAA

Features:

- Lightweight and breathable, fixed and widened waistband, adjustable in size
- Liquid silicone has excellent hydrophobicity, softer and more durable
- The anti-backflow soft edge fits better, and the anti-leakage effect is better
- Ventilation holes on both sides, internal heat dissipation naturally
- Applicable crowd: people with mobility difficulties
- 輕薄透氣彈性固定腰帶
- 可循環使用, 加厚導尿管, 臥床防漏
- 4cm加寬彈力腰帶, 多個扣孔, 可調大小
- 液體矽膠具有優良的疏水性柔軟更耐用
- 防回流軟邊能讓接尿器和身體更加貼合, 防漏效果更好
- 為保障透氣充分, 兩側開了透氣孔, 內部熱氣即可自然散出
- 適用人群: 行動不便的人士

Specifications

Product Model 產品型號	NAA
Product Material 產品材質	medical silicone glue 醫用矽膠
Product Function 產品功能	urine receiver 接尿器
Drainage Bag 引流袋	1000ml / 2000ml
Drainage Tube 引流管	1m
Men's waist 男款適用腰圍	84-95cm (2尺5-2尺8)
Women's waist 女款適用腰圍	70-84cm (2尺-2尺5)
Product Size 產品尺寸	18*15*7cm
Product Weight 產品重量	205g
Package Size 包裝尺寸	20*10*10cm
Packing Weight 包裝重量	0.26kg

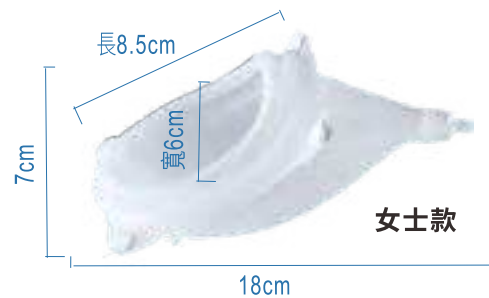
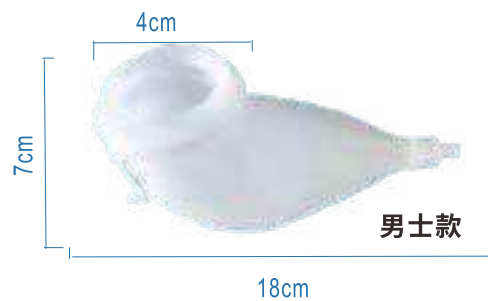
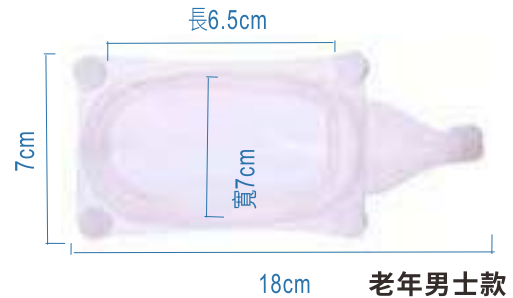

Instructions

- ◆ 將液體矽膠尿囊放入網狀固定腰帶中, 把鈕扣固定
- ◆ 將導尿管分別固定在接尿囊下端口和接尿袋上
- ◆ 將固定腰帶按正確位置擺好, 並扣上扣子
- ◆ 將鬆緊帶從胯下穿過並扣在腰帶上
- ◆ 溫馨提醒: 接尿帶一定要放置比尿囊低的位置

注意事項:

- ◆ 請勿生拉硬拽接尿門與短褲連接扣
- ◆ 側臥使用時可在雙腿間放置小枕頭, 讓雙腿間有一定間隔, 避免雙腿將漏斗擠扁引起漏尿
- ◆ 尿袋一定要放在床下, 尿液是往下流的
- ◆ 注意導管是否有彎折, 過於彎折會導致尿液流通不暢
- ◆ 使用前一定要先關閉排放口
- ◆ 本產品連續使用時間建議不能超過7天

Household Urinal for Men and Women

家用款男女款小便壺

Model: NAS

Features:

- With portable handle, easy to carry
 - There is a scale for easy measurement
 - Covered, anti-tipping liquid
 - The product is non-toxic, has no cold feeling in contact, and is easy to clean
 - Suitable for people with limited mobility or difficulty getting out of bed
-
- 具有手提柄, 方便攜帶
 - 有刻度, 便於測量
 - 有蓋, 防打翻液體
 - 產品無毒害, 接觸無冷感, 清洗方便
 - 適用人群: 行動不便或難以下床人士使用



NAS 男款(帶蓋)



NAS2 女款

Specifications

Product Model 產品型號	NAS/NAS2
Product Material 產品材質	plastic 塑膠
Product Function 產品功能	potty / chamber pot 便壺/夜壺
Product Capacity 產品容量	1200ml / 1000ml
Product Size 產品尺寸	23*13*9cm
Product Weight 產品重量	190g
Package Size 包裝尺寸	26*19*16cm
Packing Weight 包裝重量	0.32kg

Instructions

注意事項:

- ◆ 適用家庭清潔劑清洗
- ◆ 切忌勿用氯化物漂白劑消毒
- ◆ 使用後請及時清理
- ◆ 請遠離火源, 避免與鋒利的物品接觸, 以免影響使用

Sterile Drainage Urine Bag

無菌引流子母尿袋

Model: NEH

Features:

- Double hook suspension device, can be hung at the head of the bed
- The product has an anti reflux device, effectively preventing urine backflow
- The drainage tube remains soft and firm
- Foldable cross drain valve, push to open/close the drain valve
- The length of the tube is about 100CM, and the scale on the bag body is clear, making it easy to observe and treat
- 雙掛鉤懸掛裝置，掛在床頭更牢固，產品有抗回流裝置，有效防止尿液倒流
- 加粗寶塔接頭，引流管柔軟不變硬，可接三腔導尿管
- 可折疊十字排液閥，推動可以打開/關閉排液閥，排液閥可以折疊收在引流袋上
- 管長約100CM，袋身刻度清晰，便於觀察治療



Specifications

Product Model 產品型號	NEH
Product Material 產品材質	PVC
Product Capacity 產品容量	2000+200ml
Product Weight 產品重量	180g
Product Size 產品尺寸	30*27+25*8.5*5 cm
Product Model 產品型號	NEH2
Product Capacity 產品容量	2500+500ml
Product Weight 產品重量	210g
Product Size 產品尺寸	30*27+28*15.5*5 cm

Instructions

- ◆ 打開包裝，取出產品，檢查精密引流袋各部件有無破損、連接處有無斷裂。
- ◆ 關閉貯液袋和計量盒排放開關，拔除引入管一端的接頭帽，將引入管接頭與引流管或導尿管連接牢固。
- ◆ 使用床往鉤、固定繩索等固定精密引流袋。
- ◆ 適時觀察精密引流袋袋內體液容量，在液體達到規定數值時，打開排放開關，排放袋內液體。

注意事項：

- ◆ 一次性使用，產品經環氧乙烷滅菌，包裝破損或有異物禁止使用，本品貯存在無腐蝕性氣體，通風良好的室內

Daily Cystostomy With Urine Bag

日用款膀胱造口接尿袋

Model: NDB

Features:

- Latex material, reusable, high elastic webbing length adjustable
 - Adjustable belt and fixing ring are integrated, easy to use
 - Latex connected to urine bucket, leak-proof crimping design, preventing leakage and countercurrent
 - Applicable to: patients with ileum, colon, rectum or urethrostomy are used to receive excreta after operation
-
- 乳膠材質，可反復使用，高彈力腹帶長度可調
 - 調節腰帶和固定圈一體，使用方便
 - 乳膠接尿門，防漏卷邊設計，防止漏液逆流
 - 適用於：回腸、結腸、直腸或尿道造口患者術後接裝排泄物使用

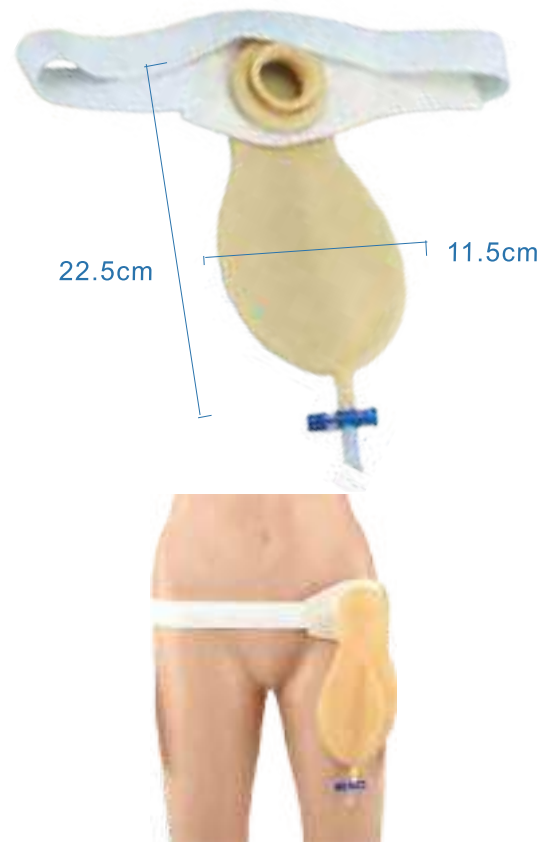

Specifications

Product Model 產品型號	NDB
Product Material 產品材質	latex 乳膠
Product Size 產品尺寸	daily urine collection bag: 22.5 * 11.5cm cross valve: 6 * 4cm belt: 90 * 4cm 日用接尿袋: 22.5*11.5cm 十字閥: 6*4cm 腰帶: 90*4cm
Product Weight 產品重量	109g
Package Size 包裝尺寸	15*15*5cm
Packing Weight 包裝重量	0.16kg

Instructions

◆將介面中間溝槽按壓卡進腹帶，將儲液袋調整和腹部垂直，將乳膠口對準造口，拉緊腹帶，使用中提拉儲液袋防止粘連及時打開排尿口排尿、減輕重量

注意事項：

- ◆腰掛袋適用於白天使用，患者帶上後便於行動和工作，不需要配合儲尿袋使用。儲尿袋掛在床邊、切勿放在床上、外出使用可將儲尿袋綁在腿上。使用時應經常沖洗晾乾、忌暴曬、烘烤、固定腹帶鬆緊要適度。對乳膠過敏者慎用。
- ◆本品配置的膠片建議粘貼使用3天左右，延期使用會影響粘貼效果，導致脫落或滲漏，並對皮膚不利；
- ◆如果袋子出現脹氣情況，請在袋體上端用針紮孔排氣，建議使用活性炭過濾片貼在排氣孔上，可去除異味；
- ◆皮膚對粘膠過敏者慎用，如在使用過程中感到不適，請立即停止使用，並向醫療專業人士諮詢；
- ◆腹帶兩件式造口袋，建議造口皮膚恢復好以後使用，平型和凹陷型等非外凸型造口請慎用。
- ◆使用時應經常沖洗晾乾，忌暴曬、烘烤，固定腹帶鬆緊要適度。對乳膠過敏者甚用。

Washable Non Slip Diaphragms

可清洗防滑式隔尿墊

Model: NAZ / NAZ2 / NAZ3

Features:

- Four layer urine barrier, effective leak proof
 - The material is soft and comfortable, close to the skin, breathable and not muggy
 - Washable, non fading, non slip and non displacement
 - Function: prevent urine and body fluid from polluting bed sheets or bedding, and can be used directly on the skin
 - Applicable to: the elderly, pregnant women, children, menstruation, etc
- 四層隔尿, 有效防漏
 - 材料柔軟舒適, 親膚透氣不悶熱
 - 可水洗, 不掉色, 使用防滑不移位
 - 作用: 阻隔尿液、體液等污染床單或被褥, 可直接貼膚使用
 - 適用於: 老人、產婦、兒童、經期等

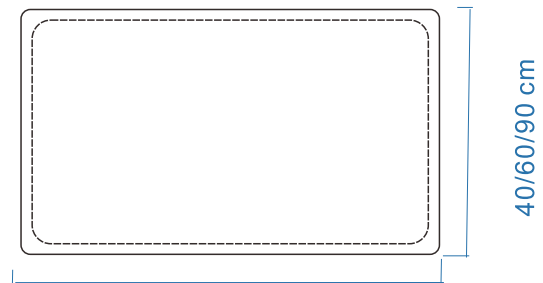

45/90/150 cm

40/60/90 cm

Specifications

Product Model 產品型號	NAZ / NAZ2 / NAZ3
Product Material 產品材質	polyester fiber, breathable mesh, absorbent cotton, TPU 聚酯纖維, 透氣網布, 吸水棉, TPU防水膜
Product Function 產品功能	barrier liquid 阻隔液體
Color 顏色	navy 藏青色
Product Size 產品尺寸	60*90cm / 40*45cm / 90*150cm
Product Weight 產品重量	365g / 98.3g / 700g
Package Size 包裝尺寸	25.5*20*7cm
Packing Weight 包裝重量	0.488kg

Instructions

- ◆ 取出後將產品放置於腰臀部即可
- ◆ 清洗時按照正常清洗方式就可以

注意事項:

- ◆ 皮膚過敏者慎用
- ◆ 對產品材料過敏者慎用
- ◆ 應存放於乾燥和通風良好的室內, 勿於酸鹼等腐蝕性物質混放
- ◆ 遠離高熱、火源等環境
- ◆ 產品使用後請及時更換清洗, 以免滋生細菌

Infant Urinary Pad

嬰兒隔尿墊

Model: NCE

Features:

- 100% cotton gauze on the surface+middle absorbent layer+bamboo cotton terry bottom, soft and anti-slip
- Cotton double-needle binding, more durable and machine washable
- Skin-friendly design, soft and breathable, waterproof and urine barrier
- Multi-functional baby urinal pad, baby stroller pad

- 表面100%純棉紗布+中間吸水層+竹棉毛圈底部, 柔軟防滑
- 純棉雙針包邊, 更耐用可機洗
- 親膚設計, 柔軟透氣, 防水隔尿
- 多功能寶寶隔尿墊、外出嬰兒推車墊



Specifications

Product Model 產品型號	NCE
Product Material 產品材質	cotton+bamboo cotton terry+polyester 棉+竹棉毛圈+聚酯纖維
Product Function 產品功能	infant urinary septum 嬰兒隔尿
Color 顏色	random 隨機
Product Size 產品尺寸	45cm*29.5cm*0.5cm
Product Weight 產品重量	0.08kg
Package Size 包裝尺寸	15*15*5cm
Packing Weight 包裝重量	0.42kg

Instructions

- ◆ 取出後將產品放置於腰臀部位即可
- ◆ 清洗時按照正常清洗方式就可以

注意事項:

- ◆ 對產品材料過敏者慎用
- ◆ 應存放於乾燥和通風良好的室內, 勿於酸鹼等腐蝕性物質混放
- ◆ 遠離高熱、火源等環境
- ◆ 產品使用後請及時更換清洗, 以免滋生細菌

Suede Waterproof Baby Care Mattress

絨面嬰兒防水護理床墊

Model: NCF

Features:

- Tough and washable, easy to wash without deformation
 - Skin-friendly design, soft and breathable, waterproof and urine barrier
 - One pad can be used for many purposes and can be carried out
- 韌耐水洗, 易洗不變形
 - 親膚設計, 柔軟透氣, 防水隔尿
 - 一墊多用, 可外出攜帶



Specifications

Product Model 產品型號	NCF
Product Material 產品材質	crystal super soft velvet+tpu waterproof film+ecological cotton 水晶超柔絨+TPU防水膜+生態棉
Product Function 產品功能	infant urinary septum 嬰兒隔尿
Product Size 產品尺寸	118.7cm*68.5cm*0.5cm
Product Weight 產品重量	0.24kg
Package Size 包裝尺寸	24cm*17cm*5cm
Packing Weight 包裝重量	0.32kg

Instructions

- ◆ 取出後將產品放置於腰臀部位即可
- ◆ 清洗時按照正常清洗方式就可以

注意事項:

- ◆ 對產品材料過敏者慎用
- ◆ 應存放於乾燥和通風良好的室內, 勿於酸鹼等腐蝕性物質混放
- ◆ 遠離高熱、火源等環境
- ◆ 產品使用後請及時更換清洗, 以免滋生細菌

Adult Diapers

成人紙尿片

Model: NFP

Features:

- ADL/embossed drainage: high water absorption, no heavy moisture
- Super absorbent core: Japanese antibacterial material, antibacterial and odor-inhibiting, long-lasting water-locking and non-reverse osmosis
- 3D anti-seepage
- Equipped with humidity indicator: easy to understand the replacement time of diapers
- The total absorption is about 5 times.

- 採用ADL/壓花排水: 高吸水性, 無重濕
- 超強吸水芯: 日本抗菌材質, 抗菌抑味, 持久鎖水不反滲
- 立體防漏圍邊
- 帶濕度指示器: 易於瞭解尿片更換時間
- 總吸收量約5次



Specifications

Product Model 產品型號	NFP
Product Material 產品材質	non woven fabric+PE bottom film+ Sumitomo polymer+PP buckle 無紡布+PE底膜+住友高分子+PP扣
Cotton Core Size 棉芯尺寸	66*34cm
Total Absorption 總吸收量	2130ml
Specifications 規格	10片/包
Waist Circumference 適合腰圍	40~58inch (102cm-147cm)
Package Size 袋裝尺寸	25*20*18cm
Packing Weight 包裝重量	1.15kg

Instructions

- ◆讓使用者側臥, 將紙尿片展開, 調整吸收芯體使其處於合適位置
- ◆協助使用者正面臥躺, 將紙尿片前腰貼部分拉起並貼合使用者腹部
- ◆讓使用者雙腿放鬆並張開, 將臀部下的紙尿片部分兩邊拉起覆蓋前腰貼
- ◆調整紙尿片位置, 拉起大腿內側的防漏隔邊, 最後將腰貼貼合固定

注意事項:

- ◆本品為一次性衛生用品, 請不要反復使用
- ◆請將本品放置於嬰幼兒無法觸及的地方, 以免發生意外
- ◆請置於常溫處保存, 避免高溫、潮濕、陽光照射
- ◆本品不溶於水請勿丟入馬桶內
- ◆使用過程中如有不適, 請立即停止使用, 並向醫生諮詢。
- ◆使用時一定要注意前後正反方向, 前方粘貼時一定要粘貼牢固
- ◆穿戴完成後請整理一下前後腰間和大腿內側的防漏隔邊, 以防沒整理好導致漏尿現象

Washable Fabric Diapers+disposable Urine Pads

可洗布尿褲+一次性尿墊

Model: NFL

Features:

- Imported TPU waterproof film, quick water absorption without leakage, breathable and non permeable to keep dry
- Adjustable Velcro for comfort and more convenient on and off
- Anti side leakage crotch, elastic leg fit
- Selected fleece fabric, more skin friendly and breathable
- 進口TPU防水覆膜, 快速吸水不滲漏, 透氣不透水保持幹爽
- 可調節魔术貼, 舒適不勒, 穿脫更方便
- 防側漏襠部, 腿部彈性貼合
- 精選抓毛面料, 更加貼膚透氣



Specifications

Product Model 產品型號	NFL
Product Material 產品材質	PUL waterproof film fabric+fleece lining PUL防水覆膜布+搖粒絨裏料
Suggested Waist Circumference 建議腰圍	1.2-3.5ft (36.6-106.7cm)
Urinary Barrier Size 隔尿巾尺寸	8*30cm/張, 100張/卷
Product Weight 產品重量	157g+208g
Package Size 包裝尺寸	21*11*14 cm
Packing Weight 包裝重量	0.44kg

Instructions

- ◆取出產品, 穿戴上後調節至合適大小即可

注意事項:

使用建議: 尿量大於500ML的建議搭配尿片使用

*請勿使用金屬清潔球等尖銳物品進行清洗;

*使用後請及時洗淨晾乾;

*請勿長期置於高溫場所, 以免變形;

*請勿接觸明火及腐蝕性液體。

◆洗滌時請將布尿褲按扣扣好, 切勿與尖銳物品一起洗滌, 防止產生勾絲。盡可能手洗以延長布尿褲使用壽命。

◆棉質面料會有輕微縮水現象, 建議冷水洗滌, 勿用烘乾機, 棉質的面料經過水洗後會越洗越柔軟, 建議整理平整後再晾有助於減少褶皺變形。

◆切勿與深色衣物一塊洗滌會有輕微掉色需要分開洗滌, 防止串色, 撞色款式, 隨浸隨洗, 不可長時間浸泡, 防止沾色染色。

Graphene Washable Sanitary Pads

石墨烯可水洗衛生理墊

Model: NFN

Features:

- ADL/embossed drainage: high water absorption, no heavy moisture
- Super absorbent core: Japanese antibacterial material, antibacterial and odor-inhibiting, long-lasting water-locking and non-reverse osmosis
- 3D anti-seepage
- Equipped with humidity indicator: easy to understand the replacement time of diapers
- The total absorption is about 5 times.

- 採用ADL/壓花排水: 高吸水性, 無重濕
- 超強吸水芯: 日本抗菌材質, 抗菌抑味, 持久鎖水不反滲
- 立體防漏圍邊
- 帶濕度指示器: 易於瞭解尿片更換時間
- 總吸收量約5次

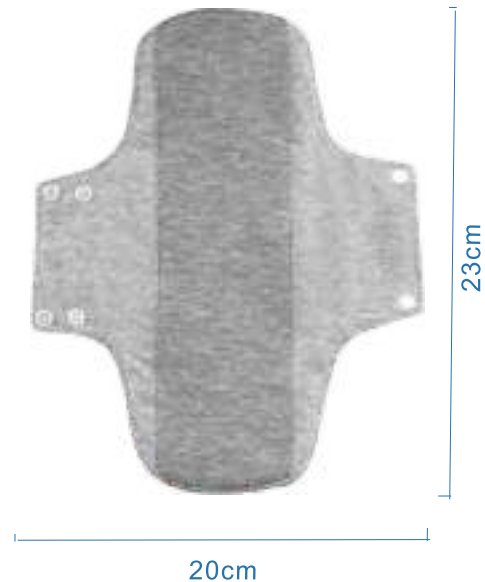

Specifications

Product Model 產品型號	NFN
Product Material 產品材質	pure cotton plain coated fabric 純棉素色覆膜布
Water Absorbing Layer Material 吸水層材質	shake fleece, antibacterial graphene 搖粒絨、抗菌石墨烯
Total Absorption 吸收層尺寸	22*7cm
Product Size 產品尺寸	23*20cm
Product Weight 產品重量	18g*3

Instructions

◆攤開衛生墊, 沿著內褲向下折, 扣上扣子, 可折疊方形隨身攜帶

注意事項:

- ◆可在平日或經期少流量日子時使用;
- ◆可搭配棉條、月經杯使用;
- ◆一包三塊, 方便清洗及交替使用;
- ◆請勿使用金屬清潔球等尖銳物品進行清洗;
- ◆使用後請及時洗淨晾乾;
- ◆請勿長期置於高溫場所, 以免變形;
- ◆請勿接觸明火及腐蝕性液體, 內側的防漏隔邊, 以防沒整理好導致漏尿現象。

Medical Care Pads

醫用護理墊

Model: NFR

Features:

- Multi layer water absorption structure, layer by layer water absorption without backflow, locking in water for a refreshing and non sticky feel
- Diamond grid embossing, quickly absorbing and diverting moisture, keeping the surface dry and dry for a long time
- Suitable for: infants, postpartum and menstrual women, and those with difficulty lying in bed
- 多層吸水結構，牢牢鎖住惡露，層層吸水不返滲，鎖水清爽不粘膩
- 菱形網格壓紋，快速吸收分流水分，菱形格結構能夠加快吸收引導惡露，保持表面持久幹爽
- 適合人群：嬰幼兒、產褥期及經期女性、臥床不便者

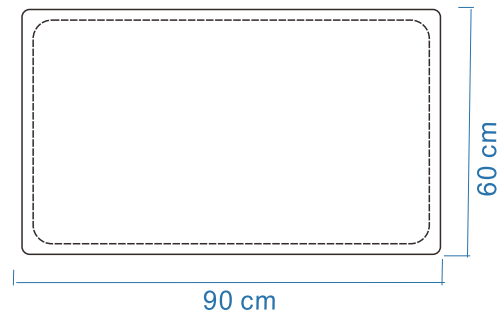

Specifications

Product Model 產品型號	NFR
Product Material 產品材質	surface : cotton non-woven fabric 表層材質：棉不織布 absorbent layer : wood pulp cotton, polymer absorbent, absorbent paper 吸收層材質：木漿棉、高分子吸收體、吸水紙 bottom : PE leak proof film 底層材質：PE防漏膜
Specifications 產品規格	60*90cm 20 pcs/bag
Specifications 袋裝尺寸	30*19*17cm
Product Weight 產品重量	1212g

Instructions

- ◆ 把醫用護理墊鋪到床上或者鋪到床單與床之間，防止排泄物排出污染弄髒床單及被褥，醫用護理墊可直接與皮膚接觸
- ◆ 取出後將產品放置於腰臀部即可

注意事項：

- ◆ 本品為一次性用品，請勿反復使用。
- ◆ 每次更換護理墊，請及時清洗並擦幹使用部位，保持皮膚幹爽。
- ◆ 如有過敏現象，請立即停止使用。
- ◆ 使用後的護理墊，切勿隨意丟棄，以免污染環境。
- ◆ 開封後，請儘早使用以避免灰塵等混入。
- ◆ 每次更換護理墊前需要用清水和肥皂洗手，避免手中細菌污染護理墊。
- ◆ 請將包裝袋置於嬰幼兒無法觸及的地方，避免窒息等意外發生，兒童需在家長的指導、監督下使用。
- ◆ 包裝後的醫用護理墊，應在常溫環境下，存放於乾燥通風、無陽光直射、無腐蝕性氣體和通風良好的室內。利用交通工具常溫下運輸。

Disposable Care Pads

一次性護理墊

Model: NFO

Features:

- Diamond grid embossing, quick diversion and absorption, quick diversion and water absorption, increasing the water absorption area, instant suction without reverse osmosis
- Free to roll over without fear of leakage, large-sized design, free to roll over and get rid of "caution"
- Suitable for: infants, postpartum and menstrual women, and those with difficulty lying in bed
- 菱格壓紋，迅速導流吸收，快速導流吸水，增大吸水面積，瞬吸不反滲
- 隨意翻身不怕漏，大尺寸設計，自在翻身，擺脫“小心翼翼”
- 適合人群：嬰幼兒、產褥期及經期女性、臥床不便者

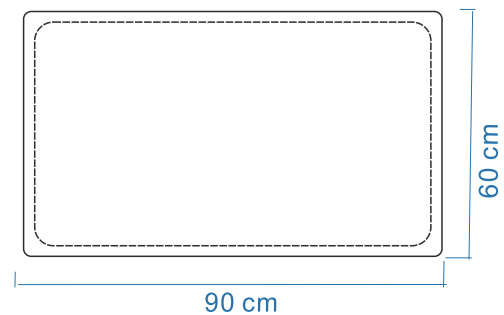

Specifications

Product Model 產品型號	NFL
Product Material 產品材質	non woven fabric, SAP absorbent molecules, wood pulp, absorbent paper, PE bottom film 無紡布、SAP吸水分子、木漿、吸水紙、PE底膜
Specifications 產品規格	60*90cm 10 pcs/bag*2
Package Size 包裝尺寸	21*36*7cm
Packing Weight 包裝重量	1.34kg

Instructions

- ◆ 把醫用護理墊鋪到床上或者鋪到床單與床之間，防止排泄物排出污染弄髒床單及被褥，醫用護理墊可直接與皮膚接觸
- ◆ 取出後將產品放置於腰臀部即可

注意事項：

- ◆ 本品為一次性用品，請勿反復使用。
- ◆ 每次更換護理墊，請及時清洗並擦幹使用部位，保持皮膚幹爽。
- ◆ 如有過敏現象，請立即停止使用。
- ◆ 使用後的護理墊，切勿隨意丟棄，以免污染環境。
- ◆ 開封後，請儘早使用以避免灰塵等混入。
- ◆ 每次更換護理墊前需要用清水和肥皂洗手，避免手中細菌污染護理墊。
- ◆ 請將包裝袋置於嬰幼兒無法觸及的地方，避免窒息等意外發生，兒童需在家長的指導、監督下使用。
- ◆ 包裝後的醫用護理墊，應在常溫環境下，存放於乾燥通風、無陽光直射、無腐蝕性氣體和通風良好的室內。利用交通工具常溫下運輸。

Life Nursing

生活護理



Removable Bedsore Washer

拆洗式褥瘡墊圈

Model: NAD

Features:

- Use 3D breathable mesh cloth to prevent stuffiness
- The pure cotton coat is elastic and skin-friendly, with better fixing effect
- Detachable outer cloth cover design, easy to clean and keep clean
- The inner sleeve effectively prevents incontinence and urine from wetting the cotton core
- Suitable for all kinds of wheelchairs and bedridden persons
- Applicable people: long-term bed rest, hemorrhoids, postoperative people, etc.
- 採用3D透氣網眼布, 防止悶熱
- 純棉外套彈性親膚, 固定效果更好
- 可拆式外布套設計, 方便清洗保持清潔
- 內套有效防止失禁尿液打濕棉芯
- 適合各種輪椅坐椅以及臥床者
- 適用人群: 長期臥床、痔瘡、術後人群等

Specifications

Product Model 產品型號	NAD
Product Material 產品材質	pure cotton cloth, waterproof cloth 3d透氣網布、純棉布、防水布
Product Function 產品功能	bedsore prevention 防褥瘡
Specifications 規格	L
Product Color 產品顏色	green 綠色
Product Size 產品尺寸	40*40*9cm
Product Weight 產品重量	0.50kg



Instructions

- ◆ 將墊圈放置於需要的部位下麵即可
- ◆ 清洗時將拉鏈拉開即可取出坐墊, 清洗外套

注意事項:

- ◆ 請遠離火源或高溫環境, 以免造成產品損壞, 防止影響使用壽命
- ◆ 請遠離潮濕環境, 以免滋生細菌
- ◆ 可用清水和洗滌劑清洗, 不要用腐蝕性液體等

Men's Hollow Postoperative Cushion

男款中空術後座墊

Model: NBE

Features:

- Sedentary, not easy to deform, high rebound cushion
- Ergonomic design and hollow design provide sufficient buffer and pressure relief space for the hip
- Strictly selected crystal velvet fabric, breathable and comfortable, sedentary and not sultry, soft and slightly elastic and close to the skin
- Suitable for people who don't use it: office workers, drivers, students and the elderly
- Purpose: travel, office, driving, postoperative recovery, etc
- 久坐不易變形, 高回彈坐墊
- 人體工學設計, 中空設計給予臀部足够的緩衝釋壓空間
- 嚴選水晶絨面料, 透氣舒爽, 久坐不悶熱, 柔軟微彈親膚
- 適合不用人群使用: 上班族、司機、學生、老人
- 用途: 旅行、辦公、駕駛、術後恢復等



Specifications

Product Model 產品型號	NBE
Product Material 產品材質	crystal velvet mesh gauze, polyether polyurethane 水晶絨網紗布, 聚醚型聚氨酯
Product Function 產品功能	Ass cushion 屁股坐墊
Product Color 產品顏色	black purple 黑紫
Product Size 產品尺寸	45*36*7cm
Product Weight 產品重量	350g
Package Size 包裝尺寸	47*40*10cm
Packing Weight 包裝重量	0.485kg

Instructions

- ◆ 將墊圈放置於需要的部位下麵即可
- ◆ 清洗時將拉鏈拉開即可取出坐墊, 清洗外套

注意事項:

- ◆ 請遠離火源或高溫環境, 以免造成產品損壞, 防止影響使用壽命
- ◆ 請遠離潮濕環境, 以免滋生細菌
- ◆ 可用清水和洗滌劑清洗, 不要用腐蝕性液體等

Postoperative Nursing Hemorrhoid Pad

術後護理痔瘡墊

Model: NBY

Features:

- Ergonomic curve design, applicable to multiple parts
 - Memory cotton inner core, pressure relief support, specially designed for lying flat and side lying
 - Large hollow design, breathable without pressure
 - Skin friendly comfort, splicing fabric, soft touch, comfortable and breathable
 - Easy to remove and wash, the zipper is smooth and easy to pull
 - Applicable people: long-term bed rest, hemorrhoids, postoperative people, etc.
-
- 符合人體工學的曲線設計, 可多部位使用
 - 記憶棉內芯, 釋壓支撐, 專為平躺、側臥設計
 - 大中空設計, 透氣不悶無壓迫
 - 親膚舒適, 拼接面料, 觸感柔軟, 舒適透氣
 - 拆洗方便, 拉鏈順滑易拉
 - 適用人群: 長期臥床、痔瘡、術後人群等



Specifications

Product Model 產品型號	NBY
Product Material 產品材質	skin friendly elastic fabric, memory cotton 親膚彈性面料、記憶棉
Product Function 產品功能	bedsore prevention 防褥瘡
Product Color 產品顏色	navy blue 藏青色
Product Size 產品尺寸	42*37*9.5cm
Product Weight 產品重量	460g

Instructions

- ◆ 將墊圈放置於需要的部位下即可
- ◆ 清洗時將拉鏈拉開即可取出坐墊, 清洗外套

注意事項:

- ◆ 請遠離火源或高溫環境, 以免造成產品損壞, 防止影響使用壽命
- ◆ 請遠離潮濕環境, 以免滋生細菌
- ◆ 可用清水和洗滌劑清洗, 不要用腐蝕性液體等

Breathable Bedsore Proof Cushion

透氣防褥瘡坐墊

Model: NAB

Features:

- Breathable sweat-absorbent cotton cloth, PVC cloth, feels cool and comfortable.
- Adopt high heat compression to accelerate the air circulation through 25 small holes with inner diameter.
- Porous/multi-gas chamber with uniform partial pressure
- Seamless edge locking, pressure-resistant and durable
- Applicable: long-term bedridden, wheelchair-ridden, lumbar postoperative recovery, pregnant women and other sedentary people.
- 透氣吸汗棉布, PVC布, 手感冰爽舒適
- 採用高熱壓縮, 加速空氣流通25個內徑小孔
- 多孔/多氣室, 均勻分壓
- 無縫鎖邊, 抗壓耐用
- 適用: 長期臥床、坐輪椅、腰椎術後恢復、孕婦等久坐久躺不同人群

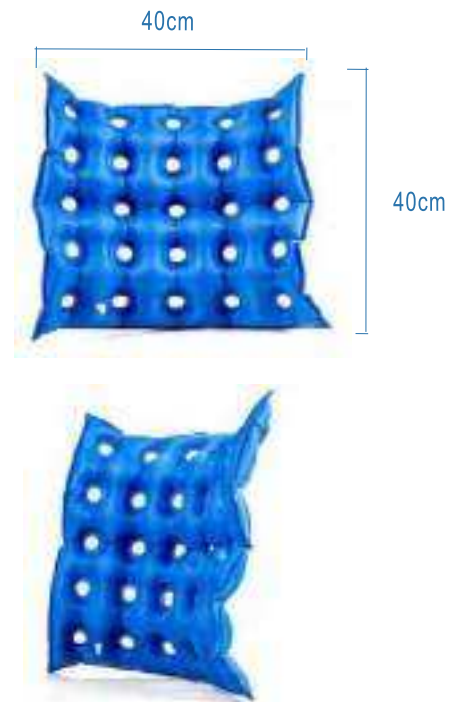

Specifications

Product Model 產品型號	NAB
Product Material 產品材質	PVC
Product Function 產品功能	bedsore prevention 防褥瘡
Product Bearing 產品承重	100kg
Product Size 產品尺寸	40*40*5cm
Product Weight 產品重量	155g
Package Size 包裝尺寸	15.5*15*5cm
Packing Weight 包裝重量	0.21kg

Instructions

- ◆ 將打氣筒插入氣墊的充氣口, 不要充得太足, 微軟, 有彈性
 - ◆ 充氣完畢將氣嘴塞緊, 以免漏氣
 - ◆ 產品受到擠壓會有輕微放氣, 需3-4天補打一次氣
- 放氣步驟
- ◆ 將密封圈輕輕往外拔出, 突出密封圈
 - ◆ 捏緊氣嘴, 聽到“吡吡”聲即可放氣

注意事項:

- ◆ 本產品充氣時一定不要充太足, 以免發生意外
- ◆ 本品承重應不超過100KG
- ◆ 用充氣泵充氣時, 要注意壓力控制, 不能超過最大壓力
- ◆ 在使用過程中, 如果發現有漏氣現象, 請停止使用
- ◆ 避免尖銳物品刺破墊體, 若不小心弄破, 嚴禁使用
- ◆ 清洗氣墊直接用中性洗滌劑清洗表面、曬乾
- ◆ 使用後注意保持清潔, 然後放在通風、乾燥處, 注意防潮
- ◆ 請不要改造本品或超出說明書的適用範圍, 否則會造成嚴重傷害

Traditional Chinese Medicine Combination Pillow

中藥頸椎組合枕(圓枕+方枕)

Model: NDA

Features:

- Take natural fresh herbs, care for cervical vertebra, and sleep deeply
- 12 kinds of traditional Chinese medicine ingredients can help you sleep soundly all night
- Easy to disassemble strap design, the zipper of the inner pillow case is dense and effective to prevent leakage
- 取材大自然清新草本, 呵護頸椎, 深度睡眠
- 12種中藥成分, 伴您健康熟睡一整晚
- 易拆卸綁帶設計, 內枕套拉鍊密實有效防漏



Specifications

Product Model 產品型號	NDA
Product Material 產品材質	brocade+linen 錦緞+亞麻
Product Function 產品功能	chinese medicine helps sleep 中藥助眠
Product Size 產品尺寸	column pillow 圓柱枕:50*9*9cm square pillow 方枕:50*30cm
Product Weight 產品重量	1620g
Package Size 包裝尺寸	48*40*15cm
Packing Weight 包裝重量	1.76kg

Instructions

- ◆ 將產品取出放置於床上躺在上面即可

注意事項:

- ◆ 枕芯不可水洗!
- ◆ 請遠離火源或高溫環境。以免造成產品損壞, 以防影響使用壽命
- ◆ 遠離潮濕環境, 以免滋生細菌
- ◆ 外套可以直接水洗

Memory Cotton Waist Cushion

記憶棉護腰靠墊

Model: NBF

Features:

- The size of the backrest is enlarged, and the saddle radian is designed to fit the S curve of the spine, making the waist more comfortable and decompression
- The design of rear elastic band is adopted to freely control the position of lumbar support and firmly fix it
- It can be disassembled and cleaned independently, which is convenient to take care of
- Suitable for: office, sedentary, postoperative backrest and other people
- 靠面加大尺寸, 馬鞍弧度設計, 貼合脊椎S曲線, 腰部更舒適, 更減壓
- 採用後置鬆緊帶的設計, 自由控制腰靠位置, 牢牢固定
- 可獨立拆卸清洗, 方便打理
- 適用於: 辦公室、久坐、術後靠背等人群

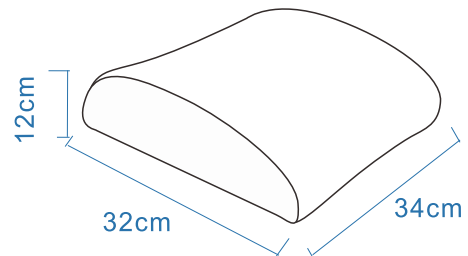

Specifications

Product Model 產品型號	NBF
Product Material 產品材質	Memory cotton, polyester 記憶棉, 聚酯纖維
Product Function 產品功能	waist soothing 腰部舒緩
Product Color 產品顏色	purple 紫色
Product Size 產品尺寸	34*32*12cm
Product Weight 產品重量	370g
Package Size 包裝尺寸	47*40*10cm
Packing Weight 包裝重量	0.49kg

Instructions

- ◆ 將產品取出套在凳子上或者需要坐靠的任意位置即可
- ◆ 將外套拉鍊取出即可清洗網套

注意事項:

- ◆ 請遠離火源或高溫環境, 以免造成產品損壞, 防止影響使用壽命
- ◆ 請遠離潮濕環境, 以免滋生細菌
- ◆ 可用清水和洗滌劑清洗, 不要用腐蝕性液體等

Push On Inflatable Lumbar Pillow

按壓式充氣腰枕

Model: NDK

Features:

- The concave design in the middle keeps the waist in a natural and comfortable state
- Press to inflate, say goodbye to the embarrassment of mouth blowing, designed for comfortable travel
- Foldable storage, convenient to carry, no space

- 中部凹型設計, 使腰部保持自然舒適狀態
- 按壓充氣, 告別嘴吹尷尬, 為舒適出行而設計
- 可折疊收納, 攜帶方便, 不占空間



Specifications

Product Model 產品型號	NDK
Product Material 產品材質	polyester+TPU coating 聚酯纖維+TPU塗層
Product Function 產品功能	support the waist 支撐腰部
Color 顏色	navy blue 藏青色
Product Size 產品尺寸	43*32*12cm
Product Weight 產品重量	129g
Package Size 包裝尺寸	15*15*5cm
Packing Weight 包裝重量	0.19kg

Instructions

◆ 蓋上後面充氣閥, 雙手重複按壓充氣閥(氣閥要打開), 充氣完成。

注意事項:

- ◆ 請勿使用金屬清潔球等尖銳物品進行清洗;
- ◆ 使用後請及時洗淨晾乾;
- ◆ 請勿長期置於高溫場所, 以免變形;
- ◆ 請勿接觸明火及腐蝕性液體。

Portable Inflatable U-shaped Pillow

便攜充氣U型枕

Model: NDI

Features:

- Neck protection design, relieve the pressure of cervical vertebra, and provide no sense of support
- Press the inflation valve gently to complete inflation,
- The concealed air outlet valve can be deflated with a slight pull
- Composite adhesive sealing makes the joint more firm and not easy to leak

- 護頸設計, 緩解頸椎壓力, 無感支撐
- 按壓式充氣閥, 輕輕按壓, 即可完成充氣,
- 隱藏式出氣閥, 輕輕一拉, 即可完成放氣
- 複合壓膠封邊, 使接縫處更牢固不易漏氣



Specifications

Product Model 產品型號	NDI
Product Material 產品材質	PVC flocking PVC植絨
Product Function 產品功能	support neck 支撐頸部
Color 顏色	malachite blue 孔雀藍
Product Size 產品尺寸	34*24*11cm
Product Weight 產品重量	85g
Package Size 包裝尺寸	15*15*5cm
Packing Weight 包裝重量	0.14kg

Instructions

◆ 蓋上後面充氣閥, 雙手重複按壓充氣閥(氣閥要打開), 充氣完成。

注意事項:

- ◆ 請勿使用金屬清潔球等尖銳物品進行清洗;
- ◆ 使用後請及時洗淨晾乾;
- ◆ 請勿長期置於高溫場所, 以免變形;
- ◆ 請勿接觸明火及腐蝕性液體。

Inflatable U-shaped Pillow With Cap

按壓充氣帶帽U型枕

Model: NDM

Features:

- Small storage, no space
- The inner liner is made of high elastic and cold resistant PVC, which is soft, durable and not easy to leak
- Shading hood design, blocking light and air conditioning
- Rotary air valve design, faster inflation/deflation speed

- 收納小巧, 不占地方
- 內膽選用高彈耐寒PVC材質, 柔軟耐用、不易漏氣
- 遮光連帽設計, 遮擋光線, 阻擋空調風
- 旋轉氣閥設計, 充氣/放氣速度更快



Specifications

Product Model 產品型號	NDM
Product Material 產品材質	cool cloth+PVC 冰爽布+PVC
Product Function 產品功能	support neck 支撐頸部
Color 顏色	grey 灰色
Product Size 產品尺寸	31*31*11cm
Product Weight 產品重量	240g
Package Size 包裝尺寸	20*10*10cm
Packing Weight 包裝重量	0.3kg

Instructions

- ◆ 將旋轉氣閥擰向OFF, 按壓充氣, 旋轉氣閥擰向ON放氣
- ◆ 洗滌方式: 內膽與外套可分開拆洗, 外套可機洗手洗內膽不可清洗(可用布擦拭乾淨)

注意事項:

- ◆ 請勿使用金屬清潔球等尖銳物品進行清洗;
- ◆ 使用後請及時洗淨晾乾;
- ◆ 請勿長期置於高溫場所, 以免變形;
- ◆ 請勿接觸明火及腐蝕性液體。

Inflatable Prone Pillow

充氣趴睡抱枕

Model: NDJ

Features:

- High quality flocking fabric, soft and skin friendly, healthy and environment-friendly
- Hot pressing seamless sealing technology, good and firm sealing
- Double air holes, quick inflation and deflation, simple and portable
- Hand digging design, release your hands and relieve fatigue
- Hollow breathing area, breathable and not stuffy
- 優質植絨面料, 柔軟親膚, 健康環保
- 熱壓無縫密封技術, 密封性好又牢固
- 雙重氣孔, 快速充氣放氣, 簡約便攜
- 挖手設計, 釋放雙手, 緩解旅途疲勞
- 中空呼吸區, 透氣不悶熱

Specifications

Product Model 產品型號	NDJ
Product Material 產品材質	PVC flocking PVC植絨
Product Function 產品功能	support head 支撐頭部
Color 顏色	grey 灰色
Product Size 產品尺寸	30*30*50cm
Product Weight 產品重量	273g
Package Size 包裝尺寸	25*20*7cm
Packing Weight 包裝重量	0.44kg



Instructions

- ◆ 將打氣筒插入氣墊的充氣口, 打氣時氣不要充得太足, 微軟, 有彈性
- ◆ 充氣完畢將氣嘴塞緊, 以免漏氣

注意事項:

- ◆ 請勿使用金屬清潔球等尖銳物品進行清洗;
- ◆ 使用後請及時洗淨晾乾;
- ◆ 請勿長期置於高溫場所, 以免變形;
- ◆ 請勿接觸明火及腐蝕性液體。

Press The Inflatable Sleeping Pillow

按壓充氣臥睡抱枕

Model: NDP

Features:

- High quality flocking fabric, soft and skin friendly, healthy and environment-friendly
- Hot pressing seamless sealing technology, good and firm sealing
- Double air holes, quick inflation and deflation, simple and portable
- Hand digging design, release your hands and relieve fatigue
- Hollow breathing area, breathable and not stuffy
- 優質植絨面料, 柔軟親膚, 健康環保
- 熱壓無縫密封技術, 密封性好又牢固
- 雙重氣孔, 快速充氣放氣, 簡約便攜
- 挖手設計, 釋放雙手, 緩解旅途疲勞
- 中空呼吸區, 透氣不悶熱



Specifications

Product Model 產品型號	NDP
Product Material 產品材質	Flocking+TPU composite cloth 植絨+TPU複合布
Product Function 產品功能	support head 支撐頭部
Color 顏色	grey 灰色
Product Size 產品尺寸	26*32*37cm
Product Weight 產品重量	350g
Package Size 包裝尺寸	21.5*11*14cm
Packing Weight 包裝重量	0.42kg

Instructions

◆將旋轉氣閥擰向OFF, 按壓充氣, 旋轉氣閥擰向ON放氣。

注意事項:

- ◆請勿使用金屬清潔球等尖銳物品進行清洗;
- ◆使用後請及時洗淨晾乾;
- ◆請勿長期置於高溫場所, 以免變形;
- ◆請勿接觸明火及腐蝕性液體。
- ◆溫馨提示: 髒了可用濕布擦拭, 無需清洗!

Wake-up Booster

起床助力器

Model: WBF

Features:

- The thick mattress can be directly placed on the bottom of the mattress for easy operation
- Butterfly triangle design, solid C-type bolt, fixed without shaking
- High quality high carbon steel main material, tool free installation, convenient assembly and disassembly
- The armrest can be adjusted (50 ~ 54cm) to meet the requirements of different thickness mattresses
- Applicable crowd: the elderly, the disabled, the injured, the disabled, pregnant women, etc
- 厚床褥可直接置壓於床褥底部使用, 操作簡單
- 蝶形三角區設計, 結實C型插銷固定不搖晃
- 優質高碳鋼主材, 免工具安裝, 裝拆方便快捷
- PU泡棉防滑扶手, 柔軟舒適更安全
- 扶手可調節(50~54CM)滿足不同厚度床墊的要求
- 適用人群: 老年人、殘疾人、受傷人士、行動不便者、孕婦等



Specifications

Product Model 產品型號	WBF
Material 材質	carbon steel + PU 碳鋼+PU
Product Function 產品功能	wake up booster 起床助力
Color 顏色	black 黑色
Product Bearing 產品承重	136kg
Product Size 產品尺寸	67*55*1.5cm
Product Weight 產品重量	2.40kg
Package Size 包裝尺寸	68*57*12.5cm
Packing Weight 包裝重量	3.50kg

Instructions

- ◆ 打開包裝取出所有配件
- ◆ 扶手對準底座兩管口插入
- ◆ 對準孔位, 左右管各插入一個C型插銷固定
- ◆ 抬起床墊, 放入床墊壓緊即安裝完成

注意事項:

- ◆ 使用前請檢查每個點的卡扣有無問題, 確認全部卡到位之後方可安心使用

Household Atomizer for Children and Adults

兒童成人家用霧化器

Model: NBB

Features:

- Handheld network, small and light, easy to carry out, anytime, anywhere, easy to atomize
 - The fog is large, the atomized particles are fine, and the particles are about $\leq 3.7 \mu\text{m}$
 - Microporous spray tablet, atomization speed $\geq 0.25\text{ml}/\text{min}$
 - The residue of liquid medicine is $\leq 0.5\text{ml}$, which is economical to use
 - The mask is comfortable, skin friendly and environment-friendly. The mask is made of PP (polypropylene) without DEHP (plasticizer / plasticizer)
-
- 手持網路式, 小巧輕便, 外出方便攜帶, 隨時隨地, 輕鬆霧化
 - 出霧大, 霧化顆粒細膩, 顆粒約 $\leq 3.7\mu\text{m}$, 藥物吸收充分
 - 微孔噴霧片, 霧化速度 $\geq 0.25\text{ml}/\text{min}$
 - 藥液殘留 $\leq 0.5\text{ml}$, 使用經濟
 - 面罩舒適, 親膚環保, 面罩採用PP (聚丙烯) 為主體的材質, 不含DEHP (即增塑劑/塑化劑)



Specifications

Product Model 產品型號	NBB
Product Material 產品材質	ABS+PP
Product Function 產品功能	medicament atomization 藥劑霧化
Medicine Cup Capacity 藥杯容量	10mL
Oscillation Frequency 振蕩頻率	100kHz+10%
Working Noise 工作噪音	$\leq 50\text{dB}$
Atomized Particles 霧化顆粒	3.7nm
Atomization Speed 霧化速度	$\geq 0.25\text{ml}/\text{min}$
Waterproof Grade 防水等級	IP22
Maximum Water Temperature 藥杯內最大水溫	$\leq 50^\circ\text{C}$
Automatic Shutdown 自動關機	Work for 20 minutes 工作20分鐘
Product Size 產品尺寸	10.5*7*4cm
Product Weight 產品重量	89g

Instructions



1. 裝入電池或接上USB線
2. 在藥杯內注入藥劑
3. 裝上霧化面罩或吸管
4. 按下開關開始霧化

注意事項:

- ◆請使用前認真閱讀產品說明書
- ◆請遠離火源及潮濕環境, 避免陽光暴曬
- ◆本產品可以兩種電源方式使用, 用電池時電量用完後請及時更換, 以免影響使用
- ◆每次使用完請及時清洗藥杯
- ◆內裡面罩請根據成人和小孩使用

Household Atomizer for Children

兒童家用霧化器

Model: NFC

Features:

- Hand-held micro-mesh atomizer, small and light, easy to carry when going out.
 - Three gears can be switched freely, and three gears of high, middle and low spray are suitable for people of different ages.
 - Atomized particles can cover the upper respiratory tract, trachea, bronchi and alveoli, and reach the affected area directly.
 - The atomized particles are fine, with particles of 10-15um in upper respiratory tract, 2-5um in 5-10um trachea and bronchi-alveoli in lower respiratory tract.
- 手持式微網霧化器, 小巧輕便, 外出方便攜帶
 - 三個檔位自由切換, 高中低三檔噴霧, 適合不同年齡人使用
 - 霧化的顆粒可覆蓋到上呼吸道、氣管及支氣管、肺泡, 直達患處
 - 霧化顆粒細膩, 顆粒10-15um上呼吸道, 5-10um氣管2-5um, 下呼吸道支氣管&肺泡



Specifications

Product Model 產品型號	NFC
Product Material 產品材質	ABS+PP
Product Function 產品功能	medicament atomization 藥劑霧化
Medicine Cup Capacity 藥杯容量	12 ml
Oscillation Frequency 振蕩頻率	100kHz+10%
Condensation Rate 冷凝速率	≥0.25ml/min
Atomized Particles 霧化顆粒	≤5μm
Atomization Speed 霧化速度	0.4 ml/min
Waterproof Grade 防水等級	IP22
Product Size 產品尺寸	11.4*4.9*5.8 cm
Product Weight 產品重量	97g

Instructions



1. 裝入電池或或接上USB線
2. 在藥杯內注入藥劑
3. 裝上霧化面罩或吸管
4. 按下開關開始霧化

模式: 1擋: 成人模式, 霧量大; 2擋: 兒童模式, 霧量中; 3擋: 嬰兒模式, 霧量小

注意事項:

- ◆請使用前認真閱讀產品說明書
- ◆請遠離火源及潮濕環境, 避免陽光暴曬
- ◆本產品可以兩種電源方式使用, 用電池時電量用完後請及時更換, 以免影響使用
- ◆每次使用完請及時清洗藥杯
- ◆內裡面罩請根據成人和小孩使用

Foldable No Bend Shampoo Basin

可折疊免彎腰洗發盆

Model: NAH

Features:

- The neck circumference is adjustable in 6 grades, and the size can be adjusted according to personal needs
- Front belt and back buckle design, pregnant women can easily wear it
- It is light and does not occupy space. It can be hung and easy to carry
- Easy drainage: there is no ponding inside the product, and the drainage pipe is directly connected to the floor drain
- Applicable groups: children, pregnant women, the elderly and inconvenient groups
- 頸圍6檔鬆緊可調, 可根據個人需求調節大小
- 前帶後扣式設計, 孕婦也能輕鬆配帶
- 輕薄不占空間, 可塞夾角、可懸掛, 方便攜帶
- 輕鬆排水: 肩頸無壓力產品內部不積水, 排水管直接連接地漏, 排水方便
- 適用人群: 兒童、孕婦、老人及不方便人群設計



Specifications

Product Model 產品型號	NAH
Product Material 產品材質	TPE+PP
Product Function 產品功能	assist in shampoo 協助行動不便人士洗頭
Expanded Size 展開尺寸	48*43*31cm
Folding Size 折疊尺寸	48*43*8cm
Water Pipe Size 水管尺寸	60-150cm
Product Weight 產品重量	637g
Package Size 包裝尺寸	52*45*8.5cm
Packing Weight 包裝重量	1.45kg

Instructions

- ◆ 將產品取出輕按展開洗發盆, 將固定帶連接在洗發盆上面連接處,
- ◆ 固定好後再將洗發盆固定於後脖處, 將固定帶固定於腰腹處
- ◆ 然後將頸圍卡扣按照自己脖子大小固定住
- ◆ 再將洗發盆下方的排水管安裝好
- ◆ 將毛巾放置於後脖處墊好, 以防磨傷脖子
- ◆ 可根據自身需要來決定是否佩戴防水耳塞

注意事項:

- ◆ 此款為塑膠製品請遠離火源或高溫環境, 以免造成產品損壞, 以防影響使用壽命
- ◆ 此產品為可折疊款, 易收納

Foldable Shampoo Basin

可折疊洗發盆

Model: NBV

Features:

- When using, the soft glue is close to the skin, so there will be no water leakage when washing
 - There is no water in the water pocket, the drain pipe can drain directly, and there is no pressure on the shoulder
 - Lightweight, space-efficient, hanging
 - Applicable to: children, pregnant women, the elderly and inconvenient people
- 使用時軟膠緊貼皮膚,在沖洗時就不會出現漏水
 - 蓄水兜內不積水,排水管可以直接排水,肩膀無壓力
 - 輕薄不占空間,可懸掛
 - 適用人群:兒童、孕婦、老人及不方便人群設計

Specifications

Product Model 產品型號	NBV
Product Material 產品材質	TPE
Product Function 產品功能	assist in shampoo 協助行動不便人士洗頭
Expanded Size 展開尺寸	54.5*40.1*4cm
Folding Size 折疊尺寸	54.5*40.1*26.2cm
Water Pipe Size 水管尺寸	MAX150cm 最長150cm
Product Weight 產品重量	600g
Package Size 包裝尺寸	47.5*41.5*5.5cm
Packing Weight 包裝重量	940g



Instructions

- ◆ 使用時根據使用者的頸圍調節大小到合適的位置即可

注意事項:

- ◆ 此款為護理物品,請遠離火源或高溫環境。以免造成產品損壞,以防影響使用壽命
- ◆ 遠離潮濕環境,以免滋生細菌
- ◆ 使用後可以直接水洗也可以將汗槽處擦拭掉即可

Silicone Waterproof Care Bib

矽膠防水護理圍兜

Model: NBU/NBU2

Features:

- Lightweight wear, widened shoulder strap to disperse pressure, and no sense of pressure when worn for a long time
 - Strong pull without deformation, soft and foldable, easy to store and carry
 - Wearing 6-gear adjustable, flexible
 - Water and oil resistant, can be washed directly, easy to clean
 - Applicable to the elderly and children who need care
- 穿戴輕盈, 加寬肩帶分散壓力, 長時間佩戴無壓力感
 - 強力拉扯不變形, 柔軟可疊, 易收納攜帶
 - 佩戴6檔可調節, 鬆緊自如
 - 防水防油, 可直接水洗, 易清洗潔淨
 - 適用於老人小孩等需照料人群

Specifications

Product Model 產品型號	NBU	NBU2
Product Material 產品材質	food grade silicone 食品級矽膠	
Product Function 產品功能	waterproof and dirt-proof 防水防髒	
Product Color 產品顏色	blue 藍色	grey 灰色
Product Size 產品尺寸	43*30*2cm	49*35*4cm
Product Weight 產品重量	170g	240g
Package Size 包裝尺寸	15.5*15*5cm	30*10*10cm
Packing Weight 包裝重量	220g	322g



Instructions

- ◆ 將產品先用水清洗, 晾乾後即可使用
- ◆ 使用時根據使用者的頸圍調節大小到合適的位置即可

注意事項:

- ◆ 此款為護理物品, 請遠離火源或高溫環境, 以免造成產品損壞, 以防影響使用壽命
- ◆ 遠離潮濕環境, 以免滋生細菌
- ◆ 使用後可以直接水洗也可以將汗槽處擦拭掉即可

Leg Wound Bath Waterproof Cover

腿部創傷沐浴防水套

Model: NBP/NBP2

Features:

- The material has strong crushing resistance and is easy to clean
- It can protect the affected area from serious deterioration in case of water
- Applicable to: daily wound care in case of leg trauma, or outdoor wound protection in rainy days. The product can be used repeatedly
- 材料防碎性強, 易清洗
- 可保護患處遇水惡化嚴重
- 主要用於: 腿部有創傷等情況下的傷口日常護理, 也可以作雨天戶外傷口的防護, 產品可反復使用



Specifications

Product Model 產品型號	NBP / NBP2
Product Material 產品材質	PVC silica gel PVC 矽膠
Product Function 產品功能	waterproof protection for legs and feet 腿部、腳部防水保護
Product Size 產品尺寸	63*42*19cm / 46*35*19cm
Product Weight 產品重量	198g / 178g
Package Size 包裝尺寸	23*20*3cm
Packing Weight 包裝重量	0.247kg / 0.227kg

Instructions

- ◆ 沐浴前, 由家人協助將其護理套的彈性密封圈子撐大
- ◆ 患者緩慢地將患肢插入套內, 盡力避免觸碰到患處
- ◆ 當患處完全入內, 讓彈性密封圈自然復位, 並同時調整彈性密封圈以便密封圈緊密
- ◆ 準備完成即可進行沐浴

注意事項:

- ◆ 沐浴時間不宜超過20分鐘
- ◆ 沐浴後護理套內外均需用幹布擦乾後收藏, 禁止用吹風機吹幹
- ◆ 產品如有破損, 禁止使用

Hand Wound Shower Waterproof Cover

手部創傷沐浴防水套

Model: NBA

Features:

- The material has strong crushing resistance and is easy to clean
- It can protect the affected area from serious deterioration in case of water
- Applicable to: daily wound care in case of hand trauma, etc. it can also be used as outdoor wound protection in rainy days. The product can be used repeatedly
- 材料防碎性強, 易清洗
- 可保護患處遇水惡化嚴重
- 主要用於: 人體手部有創傷等情況下的傷口日常護理, 也可以作雨天戶外傷口的防護, 產品可反復使用



Specifications

Product Model 產品型號	NBA
Product Material 產品材質	PVC silica gel PVC 矽膠
Product Function 產品功能	hand waterproof protection 手部防水保護
Product Size 產品尺寸	15*38*23cm
Product Weight 產品重量	108g
Package Size 包裝尺寸	16*19*3cm
Packing Weight 包裝重量	0.14kg

Instructions



1. 沐浴前, 由家人協助將其護理套的彈性密封圈子撐大
2. 患者緩慢地將患肢插入套內, 盡力避免觸碰到患處
3. 當患處完全入內, 讓彈性密封圈自然復位, 並同時調整彈性密封圈以便密封圈緊密
4. 準備完成即可進行沐浴

注意事項:

- ◆ 沐浴時間不宜超過20分鐘
- ◆ 沐浴後護理套內外均需用幹布擦乾後收藏, 禁止用吹風機吹幹
- ◆ 產品如有破損, 禁止使用

Arm Wound Shower Waterproof Cover

手臂創傷沐浴防水套

Model: NBN/NBN2

Features:

- The material has strong crushing resistance and is easy to clean
- It can protect the affected area from serious deterioration in case of water
- Applicable to: daily wound care in case of hand trauma, etc. it can also be used as outdoor wound protection in rainy days. The product can be used repeatedly
- 材料防碎性強, 易清洗
- 可保護患處遇水惡化嚴重
- 主要用於: 人體手部有創傷等情況下的傷口日常護理, 也可以作雨天戶外傷口的防護, 產品可反復使用



Specifications

Product Model 產品型號	NBN / NBN2
Product Material 產品材質	PVC silica gel PVC 矽膠
Product Function 產品功能	hand waterproof protection 手部防水保護
Product Size 產品尺寸	58*26*15cm / 55*24*15cm
Product Weight 產品重量	130g / 125g
Package Size 包裝尺寸	16*19*3cm
Packing Weight 包裝重量	0.163kg / 0.154kg

Instructions



1. 沐浴前, 由家人協助將其護理套的彈性密封圈子撐大
2. 患者緩慢地將患肢插入套內, 盡力避免觸碰到患處
3. 當患處完全入內, 讓彈性密封圈自然復位, 並同時調整彈性密封圈以便密封圈緊密
4. 準備完成即可進行沐浴

注意事項:

- ◆ 沐浴時間不宜超過20分鐘
- ◆ 沐浴後護理套內外均需用幹布擦乾後收藏, 禁止用吹風機吹幹
- ◆ 產品如有破損, 禁止使用

Foot Trauma Bath Waterproof Cover

腳部創傷沐浴防水套

Model: NBO/NBO2

Features:

- The material has strong crushing resistance and is easy to clean
- It can protect the affected area from serious deterioration in case of water
- Applicable to: daily wound care in case of foot trauma, etc. it can also be used as outdoor wound protection in rainy days. The product can be used repeatedly
- 材料防碎性強, 易清洗
- 可保護患處遇水惡化嚴重
- 主要用於: 腳部有創傷等情況下的傷口日常護理, 也可以作雨天戶外傷口的防護, 產品可反復使用

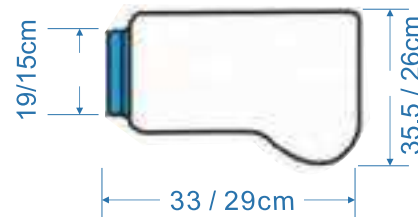

Specifications

Product Model 產品型號	NBO / NBO2
Product Material 產品材質	PVC silica gel PVC 矽膠
Product Function 產品功能	waterproof protection for feet 腳部防水保護
Product Size 產品尺寸	35.5*19*33cm / 29*26*15cm
Product Weight 產品重量	140g/108g
Package Size 包裝尺寸	23*20*3cm / 16*19*3 cm
Packing Weight 包裝重量	0.193kg / 0.143kg

Instructions

- ◆ 沐浴前, 由家人協助將其護理套的彈性密封圈子撐大
- ◆ 患者緩慢地將患肢插入套內, 盡力避免觸碰到患處
- ◆ 當患處完全入內, 讓彈性密封圈自然復位, 並同時調整彈性密封圈以便密封圈緊密
- ◆ 準備完成即可進行沐浴

注意事項:

- ◆ 沐浴時間不宜超過20分鐘
- ◆ 沐浴後護理套內外均需用幹布擦乾後收藏, 禁止用吹風機吹幹
- ◆ 產品如有破損, 禁止使用

Foot Trauma Bath Waterproof Cover

足部創傷沐浴防水套

Model: NFD/NFF

Features:

- The material has strong crushing resistance and is easy to clean
- It can protect the affected area from serious deterioration in case of water
- Applicable to: daily wound care in case of foot trauma, etc. it can also be used as outdoor wound protection in rainy days. The product can be used repeatedly
- 材料防碎性強, 易清洗
- 可保護患處遇水惡化嚴重
- 主要用於: 腳部有創傷等情況下的傷口日常護理, 也可以作雨天戶外傷口的防護, 產品可反復使用

Specifications

Product Model 產品型號	NFD/NFF
Product Material 產品材質	PVC silica gel PVC 矽膠
Product Function 產品功能	waterproof protection for feet 腿部防水保護
Product Size 產品尺寸	78*44*18cm / 68*33*17cm
Product Weight 產品重量	143g / 129g
Package Size 包裝尺寸	20*20*4cm
Packing Weight 包裝重量	0.246kg / 0.235kg



Instructions

- ◆ 沐浴前, 由家人協助將其護理套的彈性密封圈子撐大
- ◆ 患者緩慢地將患肢插入套內, 盡力避免觸碰到患處
- ◆ 當患處完全入內, 讓彈性密封圈自然復位, 並同時調整彈性密封圈以便密封圈緊密
- ◆ 準備完成即可進行沐浴

注意事項:

- ◆ 沐浴時間不宜超過20分鐘
- ◆ 沐浴後護理套內外均需用幹布擦乾後收藏, 禁止用吹風機吹幹
- ◆ 產品如有破損, 禁止使用

Leg Trauma Bath Waterproof Cover

腿部創傷沐浴防水套

Model: NFE

Features:

- The material has strong crushing resistance and is easy to clean
- It can protect the affected area from serious deterioration in case of water
- Applicable to: daily care of wounds in the case of leg trauma, etc., and can also be used for outdoor wound protection in rainy days. The product can be used repeatedly.
- 材料防碎性強, 易清洗
- 可保護患處遇水惡化嚴重
- 主要用於: 腿部有創傷等情況下的傷口日常護理, 也可以作雨天戶外傷口的防護, 產品可反復使用

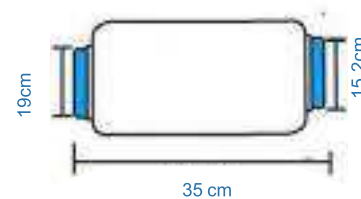

Specifications

Product Model 產品型號	NFE
Product Material 產品材質	PVC silica gel PVC 矽膠
Product Function 產品功能	wound waterproof protection 傷口防水保護
Product Size 產品尺寸	35*19*15.2cm
Product Weight 產品重量	218g
Package Size 包裝尺寸	22.5*20*3m
Packing Weight 包裝重量	0.268kg

Instructions

- ◆ 沐浴前, 由家人協助將其護理套的彈性密封圈子撐大
- ◆ 患者緩慢地將患肢插入套內, 盡力避免觸碰到患處
- ◆ 當患處完全入內, 讓彈性密封圈自然復位, 並同時調整彈性密封圈以便密封圈緊密
- ◆ 準備完成即可進行沐浴

注意事項:

- ◆ 沐浴時間不宜超過20分鐘
- ◆ 沐浴後護理套內外均需用幹布擦乾後收藏, 禁止用吹風機吹幹
- ◆ 產品如有破損, 禁止使用

Gel Ball Eye Mask - (Cold/Hot Compress)

凝膠球眼罩- (可冷敷、熱敷)

Model: NEY

Features:

- Used to relieve discomfort such as eye swelling, dark circles, headaches, etc
- Both cold and hot compresses are available
- Gel eye mask for making frozen eye bags, repeated use, gel beads can remain flexible even when frozen at -18 °C
- Double sided design: one side is made of ice bag for cooling, while the other side is made of soft plush fabric
- 用於緩解眼部浮腫、黑眼圈、頭痛等不適
- 冷敷熱敷均可用
- 凝膠眼罩製作凍眼袋, 反復使用, 凝膠珠-18°C下冷凍都可以保持柔韌
- 雙面設計: 一面冰袋降溫, 另一面由柔軟毛絨織物做, 確保隨時最佳安全性



Specifications

Product Model 產品型號	NEY
Product Material 產品材質	Water, glycerin, sodium polyacrylate, elastic band, ultra soft fabric 水、甘油、聚丙烯酸鈉、彈性帶、超柔面料
Product Size 產品尺寸	29*9cm
Strap Size 綁帶尺寸	17 cm
Product Weight 產品重量	109g
Package Size 包裝尺寸	15*15*5cm
Packing Weight 包裝重量	0.163kg

Instructions

- ◆ 冷敷: 將產品放入冰箱冷藏室30-60分鐘(冷凍室15-30分鐘)再將產品取出, 用手揉搓下, 達到體感舒適溫度後可以直接使用。
- ◆ 熱敷: 將產品放入微波爐中(中低火)加熱10秒, 不熱可延長加熱時間但不可一次性設置1-2分鐘。
- ◆ 因微波爐的功率不同, 可適當調節加熱時間, 但不可加熱時間過長, 以免損壞商品。

Gel Ball Cooling Forehead Protection Patch

凝膠球降溫護額貼

Model: NEZ

Features:

- The material has strong crushing resistance and is easy to clean
- It can protect the affected area from serious deterioration in case of water
- Applicable to: daily care of wounds in the case of leg trauma, etc., and can also be used for outdoor wound protection in rainy days. The product can be used repeatedly.
- 材料防碎性強, 易清洗
- 可保護患處遇水惡化嚴重
- 主要用於: 腿部有創傷等情況下的傷口日常護理, 也可以作雨天戶外傷口的防護, 產品可反復使用



Specifications

Product Model 產品型號	NEY
Product Material 產品材質	Water, glycerin, sodium polyacrylate, elastic band, ultra soft fabric 水、甘油、聚丙烯酸鈉、彈性帶、超柔面料
Product Size 產品尺寸	31*9cm
Strap Size 綁帶尺寸	17 cm
Product Weight 產品重量	168g
Package Size 包裝尺寸	15*15*5cm
Packing Weight 包裝重量	0.26kg

Instructions

- ◆ 冷敷: 將產品放入冰箱冷藏室30-60分鐘(冷凍室15-30分鐘)再將產品取出, 用手揉搓下, 達到體感舒適溫度後可以直接使用。
- ◆ 熱敷: 將產品放入微波爐中(中低火)加熱10秒, 不熱可延長加熱時間但不可一次性設置1-2分鐘。
- ◆ 因微波爐的功率不同, 可適當調節加熱時間, 但不可加熱時間過長, 以免損壞商品。

EVA Sensory Tactile Double-sided Cleaning Brush

EVA感統觸覺雙面清潔刷

Model: NEC

Features:

- Insulation protection, easy assembly
- Silicone whiskers, soft to the touch, do not harm the skin, are not prone to short whiskers, and are durable and long-lasting
- Even distribution of tactile points, long and soft tendrils, with massage effect
- 絕緣保護, 裝配方便
- 矽膠觸鬚, 手感柔軟, 不傷肌膚, 不易短須, 經久耐用
- 觸覺點分佈均勻, 長柔軟觸鬚, 具有按摩效果

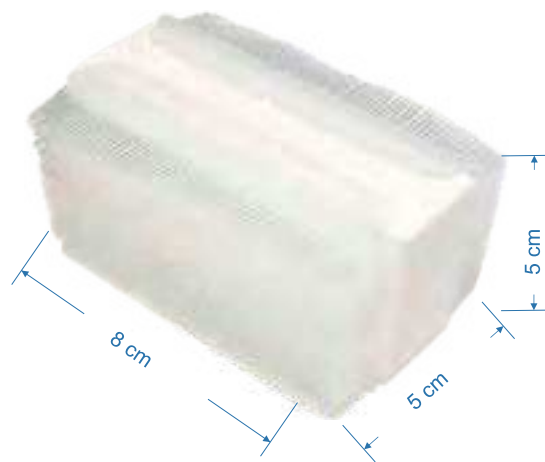

Specifications

Product Model 產品型號	NEC
Product Material 產品材質	soft silicone brush 柔軟矽膠刷
Product Size 產品尺寸	8*5*5cm
Product Weight 產品重量	31g
Package Size 包裝尺寸	10*10*5cm
Packing Weight 包裝重量	0.06kg

Instructions

- ◆ 取出產品, 按需使用即可

注意事項:

- ◆ 請勿使用金屬清潔球等尖銳物品進行清洗;
- ◆ 使用後請及時洗淨晾乾;
- ◆ 請勿長期置於高溫場所, 以免變形;
- ◆ 請勿接觸明火及腐蝕性液體。可適當調節加熱時間, 但不可加熱時間過長, 以免損壞商品。

Touch Perception Training Sponge Brush

觸覺感知訓練海綿刷

Model: NEA

Features:

- Insulation protection, easy assembly
 - Silicone whiskers, soft to the touch, do not harm the skin, are not prone to short whiskers, and are durable and long-lasting
 - One side sponge and one side silicone adhesive
 - Even distribution of tactile points, long and soft tendrils, with massage effect
-
- 絕緣保護, 裝配方便
 - 矽膠觸鬚, 手感柔軟, 不傷肌膚, 不易短須, 經久耐用
 - 一面海綿一面矽膠
 - 觸覺點分佈均勻, 長柔軟觸鬚, 具有按摩效果



Specifications

Product Model 產品型號	NEA
Product Material 產品材質	soft silicone brush+sponge 柔軟矽膠刷+海綿
Product Size 產品尺寸	8*4.5*3.5cm
Product Weight 產品重量	14g
Package Size 包裝尺寸	10*10*5cm
Packing Weight 包裝重量	0.06kg

Instructions

- ◆ 取出產品, 按需使用即可

注意事項:

- ◆ 請勿使用金屬清潔球等尖銳物品進行清洗;
- ◆ 使用後請及時洗淨晾乾;
- ◆ 請勿長期置於高溫場所, 以免變形;
- ◆ 請勿接觸明火及腐蝕性液體。可適當調節加熱時間, 但不可加熱時間過長, 以免損壞商品。

Disposable Oral Care Stick

一次性口腔護理棒

Model: NEB

Features:

- Plastic handle design, lightweight and easy to grip without scratching hands, not easy to breed bacteria
- High density, high adsorption rate, no damage to mucosa and periodontal tissue
- Polygonal brush head, easy to extend into concave wounds for cleaning, and easier care
- Can be used for autism swallowing training, body surface cleaning, oral muscle language recovery training, etc
- 塑膠柄設計，輕巧易握不劃手，不易滋生細菌
- 高密度，吸附率高，不損傷粘膜，牙周組織
- 多邊形刷頭，方便伸入凹型的創面進行清潔，護理更輕鬆
可用於自閉吞嚥訓練、人體體表清潔、口肌語言恢復訓練等



Specifications

Product Model 產品型號	NEB
Product Material 產品材質	PP+sponge PP+海綿
Packaging Specifications 包裝規格	10pcs
Product Size 產品尺寸	11*2*2cm
Product Weight 產品重量	1.2g*10
Package Size 包裝尺寸	12*12*5cm
Packing Weight 包裝重量	0.04kg

Instructions

- ◆ 皮膚消毒：打開小包裝，手持塑膠棒，將海綿頭浸取適量的消毒液，然後對身體需要部位按消毒規範進行消毒操作。
- ◆ 口腔護理：打開小包裝，手持塑膠棒，將海綿頭浸取適量的護理液，對口腔進行護理，然後，再打開另一支本產品，浸取溫水（注意：水溫不超過攝氏32度），清洗口腔。

Waterproof and Oil Resistant Adult Bib

防水防油成人飯兜

Model: NEI

Features:

- TPU material leak proof rice bag, waterproof material, to avoid wetting the clothes inside
 - Large caliber, three-dimensional bib, easy to hold scattered food
 - Waterproof and stain resistant, easy to clean with just one wipe, made of non washable material, fearless of stains
 - Adjustable Velcro, easy to put on and take off, adjustable neck circumference, comfortable without constricting the neck, more convenient to put on and take off
-
- TPU材質防漏飯兜，防水材質，避免弄濕裏面的衣服
 - 大口徑，立體圍兜，輕鬆兜住散落的食物
 - 防水防汙，一擦即淨，免洗材質，無懼污漬
 - 可調節魔术貼，穿脫自由，頸圍可調，舒適不勒脖，穿脫更方便



Specifications

Product Model 產品型號	NEI
Product Material 產品材質	TPU+polyester fiber TPU+聚酯纖維
Product Size 產品尺寸	96*81cm
Bib Size 圍嘴尺寸	34*9*3.5cm
Product Weight 產品重量	140g
Packing Weight 包裝重量	0.06kg

Instructions

- ◆ 取出產品，穿戴上後調節至合適大小即可

注意事項：

- ◆ 請勿使用金屬清潔球等尖銳物品進行清洗；
- ◆ 使用後請及時洗淨晾乾；
- ◆ 請勿長期置於高溫場所，以免變形；
- ◆ 請勿接觸明火及腐蝕性液體。

Easy to Wear and Take off Care Clothing

易穿脫護理服

Model: NEJ/NEK

Features:

- Pull and paste, easy to put on and take off, one piece fully open design, convenient for putting on and taking off, scrubbing, injection, inspection, changing clothes, etc
- Elastic waistband without restricting the body, suitable for both fat and thin
- Cotton fabric, breathable and sweat absorbent
- Detachable waist, pull down for easy replacement of urine bags
- 一拉一貼, 輕鬆穿脫, 一片式全開設計, 方便穿脫、擦洗、打針、檢查、換衣等
- 鬆緊褲腰頭不勒身, 胖瘦都宜
- 棉面料, 透氣吸汗
- 可拆卸腰頭, 往下拉可方便尿包替換



NEJ-男款



NEK-女款

Specifications

Product Model 產品型號	NEJ/NEK
Product Material 產品材質	cotton+velcro 棉+魔术貼
Suitable height 適合身高	170-175cm / 150-160cm
Weight 適合體重	62.5-70kg / 50-57.5cm
Product Size 產品尺寸	clothing length 衣長: 74cm / 68cm bust 胸圍: 115cm / 104cm sleeve length 肩加袖長: 72cm / 62cm pant length 褲長: 100cm / 92cm hip 臀圍: 110cm / 104cm waistband 褲腰頭: 75cm / 67cm
Product Weight 產品重量	640g / 575g

Instructions

- ◆ 取出產品, 穿戴上後調節至合適大小即可。

注意事項:

- ◆ 請勿使用金屬清潔球等尖銳物品進行清洗;
- ◆ 使用後請及時洗淨晾乾;
- ◆ 請勿長期置於高溫場所, 以免變形;
- ◆ 請勿接觸明火及腐蝕性液體。

Frozen Ice Packs

冷凍冰袋

Model: NEO

Features:

- Reusable, dual-purpose for cold and hot compress, compact and portable
- Applicable to: breast milk preservation, cold fan cooling, food preservation, fishing preservation, sports cold compress
- 可反復使用, 冷熱敷兩用, 小巧便攜
- 適用: 母乳保鮮、冷風扇製冷、食品保冷、釣魚保鮮、運動冷敷



Specifications

Product Model 產品型號	NEO
Product Material 產品材質	PE
Specifications 規格	3pcs
Product Size 產品尺寸	18.8*12.5cm
capacity 容量	250ml
Product Weight 產品重量	259g

Instructions

◆本產品無需加水, 直接放入冰箱冷凍8小時以上, 然後取出放入所需處即可。

注意事項:

- ◆冷敷或物理降溫時, 請用毛巾或者棉布包裹, 以免溫度過低, 造成凍傷。
- ◆禁止用尖銳物劃傷冰袋, 若破損滲漏請勿繼續使用。
- ◆本品無毒, 但不可食用, 請放置在兒童不能接觸的地方。

Mini Cold and Hot Compress Bag

迷你冷熱敷袋

Model: NEP

Features:

- Cold compress: headache, fever, toothache, heatstroke, scald, muscle strain, sprain, external injury hemostasis, beauty, etc.
- Hot compress: joint pain, dysmenorrhea, stomach discomfort, lumbar muscle strain, warm hands, waist, stomach, etc. in winter.
- Reusable, dual-purpose for cold and hot compress, compact and portable
- 冷敷：頭痛發燒、牙痛、中暑、燙傷、肌肉拉傷、扭傷、外傷止血、美容等
- 熱敷：關節疼痛、痛經、胃部不適、腰肌勞損、冬天熱敷暖手、暖腰、暖胃等
- 可反復使用，冷熱敷兩用，小巧便攜



Specifications

Product Model 產品型號	NEQ
Product Material 產品材質	polyester spinning+gel 滌絲紡+凝膠
Specifications 規格	2 pcs
Product Size 產品尺寸	10*13cm
Product Weight 產品重量	80g

Instructions

◆冰敷方法

- 方法一：急用時放冰箱冷凍30分鐘
- 方法二：放冰箱冷藏室1小時即可用
- 方法三：放冰水中泡10分鐘即可用

◆熱敷方法

- 方法一：放熱水中泡3到5分鐘，用毛巾擦幹後使用
- 方法二：用濕毛巾包好，放微波爐內中火加熱30秒即可使用

注意事項：

- ◆冷熱袋僅供外用，如內容物接觸眼睛或皮膚，應用清水徹底清洗。
- ◆如不慎誤食內容物，應飲下大量清水及儘量吐出，必要時應聯繫醫生。
- ◆為防止溫度過高或過低，剛開始使用時最好用毛巾或棉布包裹，如使用者循環系統有病，應先請教醫生。

Disposable Quick Cooling Ice Bag

一次性速冷冰袋

Model: NEQ

Features:

- Squeeze to quickly cool down, no need to wait, cool down, reduce fever, save time and worry! Convenient and fast
- Quick cooling, no need for refrigeration, portable cooling, convenient for use at any time
- The bag contains coolant liquid and ice crystals, which can be compressed and broken to cool down
- Used for physical antipyretic and cold compress therapy, only for closed soft tissues

- 擠壓迅速降溫，無需等待，降溫、退燒、省時省心！方便快捷
- 速冷，無需冷藏，便攜降溫，方便隨時使用
- 袋內含冷卻液體和冰晶，擠壓破裂即可製冷
- 用於物理退熱、冷敷治療，僅用於閉合性軟組織



Specifications

Product Model 產品型號	NEQ
Product Material 產品材質	PE composite PA PE複合PA
Specifications 規格	3pcs
Warranty Period 質保期	3 years
Product Size 產品尺寸	17*115cm
Product Weight 產品重量	100g

Instructions

◆ 找到冰袋裏面的液體包，用力捏破內袋，3秒鐘內即可致冷，並上下抖動使內容物充分混合。

注意事項：

- ◆ 冰袋僅供外用，如內容物接觸眼睛或皮膚，應用清水徹底清洗。
- ◆ 如不慎誤食內容物，應飲下大量清水及儘量吐出，必要時應聯繫醫生。
- ◆ 本品是一次性產品，用完請扔進垃圾桶。

Wrist Cold and Hot Compress Ice Patch

手腕冷熱敷冰帖

Model: NFH

Features:

- Gel ice hot compress for hand protection, ice/hot compress for circular use
- Solid gel new technology, more convenient to use than liquid, with longer temperature storage effect
- Antibacterial Lycra fabric, high elasticity, more comfortable, and more fitting
- 凝膠冰熱敷護手, 冰敷/熱敷循環使用
- 固體凝膠新科技, 相比於液態使用更方便, 存溫效果更長久
- 抗菌萊卡面料, 彈力大, 更舒適, 更貼合



Specifications

Product Model 產品型號	NFH
Product Material 產品材質	lycra, solid gel 萊卡、固體凝膠
Specifications 規格	2 pcs
Product Size 產品尺寸	length 長度:20cm palm circumference 掌圍:25cm
Product Weight 產品重量	222g

Instructions

- ◆冷敷: 將產品放入冰箱冷藏室30-60分鐘(冷凍室15-30分鐘)再將產品取出, 用手揉搓下, 達到體感舒適溫度後可以直接使用。
- ◆熱敷: 將產品放入微波爐中(中低火)加熱10秒, 不熱可延長加熱時間但不可一次性設置1-2分鐘。
- ◆因微波爐的功率不同, 可適當調節加熱時間, 但不可加熱時間過長, 以免損壞商品。

注意事項:

- ◆ 如果需要再次加熱產品, 需等待其冷卻後加熱, 不可煮沸包裝。
- ◆ 如果在使用過程中有不適現象, 應立即停止使用並儘快就醫, 如有破損請停止使用。

75% Alcohol Disinfectant Cotton Pads

一次性75%酒精消毒棉片

Model: NFI/NFJ

Features:

- Breathable non-woven fabric: The interior is made of breathable and flexible non-woven fabric, which is non shedding, non irritating, and quickly evaporates without residue
- Each piece is individually packaged with lightweight tin foil, which has a long moisturizing time, is easy to carry, and is easy to tear off
- Disposable, sterilized and disinfected, clean and cared for, always available for home and travel

- 透氣無紡布：內部採用透氣柔韌無紡布、不掉毛、無刺激，快速揮發無殘留
- 每片均採用輕薄錫箔紙獨立包裝，保濕時間長、攜帶方便、易撕用
- 一次性使用，殺菌消毒，清潔護理，居家旅行常備



Specifications

Product Model 產品型號	NFI/NFJ
Product Material 產品材質	75% alcohol, non-woven fabric 75%酒精、無紡布
Specifications 規格	100pcs/box
Warranty Period 質保期	3 years
Product Size 產品尺寸	6*3cm / 6*6cm
Product Weight 產品重量	84g / 116g

Instructions

- ◆ 去除包裝即可使用。

注意事項：

- ◆ 僅供外用；
- ◆ 單片一次性使用,用後請丟棄；
- ◆ 避免接觸眼睛；
- ◆ 請置於兒童不易接觸的地方。

75% Alcohol Disinfectant Cotton Pads

75%酒精消毒濕巾

Model: NFK

Features:

- Independently packaged and ultra portable, easy to carry in your pocket when going out, wherever you go
 - Flexible and tear resistant, non shedding, comfortable and breathable, easy to wipe
 - Select high-quality non-woven fabric, soft, skin friendly, breathable, and absorbent
 - Mild formula without irritation, sterilization without hurting hands
- 獨立包裝超便攜,出門輕鬆揣兜裏,走到哪兒帶到哪兒
 - 柔韌耐撕,不掉絮,舒適透氣,隨心擦拭
 - 選用優質無紡布,柔軟親膚透氣吸水
 - 溫和配方不刺激,殺菌不傷手



Specifications

Product Model 產品型號	NFK
Product Material 產品材質	75% alcohol, non-woven fabric 75%酒精、無紡布
Specifications 規格	50pcs/box
Warranty Period 質保期	2 years
Product Size 產品尺寸	14*18cm
Product Weight 產品重量	255g

Instructions

- ◆ 去除包裝即可使用。

注意事項:

- ◆ 僅供外用;
- ◆ 單片一次性使用,用後請丟棄;
- ◆ 避免接觸眼睛;
- ◆ 請置於兒童不易接觸的地方。

Baby Pentagonal Bathing Net Bag

嬰兒五角沐浴網兜

Model: NCD

Features:

- The five corner anti slip design is safe and firm to prevent the baby from sliding into the water
- Smooth lines, fit the baby's back, reasonable support and safer
- Adjustable length: the length of the bath net can be adjusted by crimping the buckle
- It is thickened and soft to protect the small head. It is soft and elastic, and the baby is more comfortable to take a bath
- Applicable to: babies aged 0-18 months
- 五角防滑設計, 安全牢固, 防止寶寶滑入水中
- 流暢線條, 貼合寶寶背部, 合理承托更安全
- 可調節長短: 通過捲縮浴網兩邊的卡扣可調節浴網的長度控制寶寶到水面的距離
- 加厚柔軟, 保護小腦袋, 柔軟高彈, 寶寶洗澡更舒服
- 適用於: 0-18個月寶寶



Specifications

Product Model 產品型號	NCD
Product Material 產品材質	Sandwich mesh + loop flannel 三明治網布+圈絨布
Product Function 產品功能	Baby bathing aid 嬰兒洗澡輔助
Color 顏色	Light green 淺綠色
Operation Mode 操作方式	Snap type 卡扣式
Product Size 產品尺寸	47*33*31cm
Product Weight 產品重量	150g
Package Size 包裝尺寸	25.5*20*7cm
Packing Weight 包裝重量	0.232kg

Instructions

- ◆ 將產品取出, 將5條卡扣帶按照對應的位置卡在浴盆的邊緣, 可根據所需長度來調節使用長度
- ◆ 調節長短時直接向一方卷起即可
- ◆ 請使用後擰幹水, 放置於通風處

注意事項:

- ◆ 對產品材料過敏者慎用
- ◆ 應存放於乾燥和通風良好的室內, 勿於酸鹼等腐蝕性物質混放
- ◆ 遠離高熱、火源等環境
- ◆ 產品使用後請及時更換清洗, 以免滋生細菌
- ◆ 使用時請確認卡扣已經全部卡到位, 以免發生意外

Concealed Urine Bag Messenger Bag

隱蔽式尿袋斜挎包

Model: NDH

Features:

- Fashionable appearance, hidden urine bag, adjustable shoulder strap length
- The drainage bag is fixed with a lanyard to prevent sagging and backflow
- The bottom end is designed with velcro, which can be opened to release liquid
- Lined with waterproof fabric to prevent soiling
- 外觀時尚, 隱藏尿袋, 肩帶的長短可以調節
- 系繩固定引流袋, 防止下垂倒流
- 底端魔术貼設計, 整體打開釋放出液體
- 內襯防水面料, 防止弄髒衣服



Specifications

Product Model 產品型號	NDH
Product Material 產品材質	mesh+waterproof lining 網+防水內襯
Product Function 產品功能	hide urine bag 隱藏尿袋
Color 顏色	black 黑色
Product Size 產品尺寸	29*19cm
Product Weight 產品重量	105g
Package Size 包裝尺寸	15*15*5cm
Packing Weight 包裝重量	0.16kg

Instructions

注意事項:

- ◆ 請勿使用金屬清潔球等尖銳物品進行清洗;
- ◆ 使用後請及時洗淨晾乾;
- ◆ 請勿長期置於高溫場所, 以免變形;
- ◆ 請勿接觸明火及腐蝕性液體。

Concealed Urine Bag Messenger Bag

隱蔽式尿袋斜挎包

Model: NET

Features:

- Waterproof fabric, easy to clean, preventing clothes from getting dirty
- The length can be adjusted freely, connected with a Japanese buckle, and the ribbon is soft, comfortable, and skin friendly. There is a drainage port at the bottom
- Target audience: Fixed drainage straps to avoid embarrassment when going out, suitable for use with nephrostomy or bile drainage bags, etc
- 防水面料, 方便清洗, 防止弄髒衣服
- 長度隨意調, 日字扣連接, 織帶柔軟舒服親膚, 底部有引流口
- 適用人群: 固定引流帶, 避免出門尷尬, 腎造瘻或者膽汁引流袋等都適合使用



Specifications

Product Model 產品型號	NET
Product Material 產品材質	waterproof oxford cloth 防水牛津布
Product Function 產品功能	hide urine bag 隱藏尿袋
Color 顏色	black 黑色
Product Size 產品尺寸	30*22.5cm
Product Weight 產品重量	120g
Package Size 包裝尺寸	25*17*55cm
Packing Weight 包裝重量	0.186kg

Instructions

◆取出產品, 將尿袋下方管往上折在放進包裹, 即可背帶, 肩帶調整至適合位置即可。

注意事項:

- ◆請勿使用金屬清潔球等尖銳物品進行清洗;
- ◆使用後請及時洗淨晾乾;
- ◆請勿接觸明火及腐蝕性液體。

Medical Tools

醫用工具



Disposable Belt Type Anorectal Pouch

一次性腰帶式肛腸造口袋

Model: NDC

Features:

- Fish silk fabric, comfortable, breathable and not stuffy
- Blue waterproof cloth, easy to clean
- 16cm special ejection hook, adjust the tightness freely, not easy to fall off
- Fixed clip design, rotatable chassis, so that patients can be used in sitting, lying, standing and other positions
- Applicable to: stoma cleaning, nursing and excreta collection
- 魚絲面料, 舒適透氣不悶熱
- 藍色防水佈, 易清潔
- 16cm專用射出鉤, 隨心調節鬆緊度, 不易脫落
- 固定夾子設計, 可旋轉式底盤, 讓患者在坐姿、躺姿、站姿等姿勢下均可適用
- 適用於: 造口清洗、護理和排泄物的收集



總長100cm



Specifications

Product Model 產品型號	NDC
Product Material 產品材質	silicone+plastic bag+elastic belt 矽膠+塑膠袋+彈性腰帶
Color 顏色	blue and white 藍白色
Product Size 產品尺寸	belt: 100cm ± 10% long, 6cm wide, with 20cm adjustable buckle inner diameter: 2.5-5cm, can be cut 腰帶: 長100cm±10%, 寬6cm, 有20cm調節粘扣 內徑: 2.5-5cm可剪裁
Product Weight 產品重量	99g
Package Size 包裝尺寸	15*15*5cm
Packing Weight 包裝重量	0.15kg

Instructions

- ◆ 將肛門袋套在肛門圈外沿上, 用卡子卡好或皮筋, 一定要套緊、套牢。
- ◆ 將肛門圈兩邊的布帶圈在腰部, 使肛門圈對準改造口位置, 調節到適宜的緊度, 系好即可。
- ◆ 及時更換肛門袋。

注意事項:

- ◆ 請勿使用金屬清潔球等尖銳物品進行清洗;
- ◆ 使用後請及時洗淨晾乾;
- ◆ 請勿長期置於高溫場所, 以免變形;
- ◆ 請勿接觸明火及腐蝕性液體。

Adjustable Pressure Dialysis Tourniquet

可調節壓力透析止血帶

Model: NDG

Features:

- The length can be adjusted freely, durable, spacious, soft and comfortable
 - High elasticity, no deformation after repeated use
 - Widened Velcro with strong fixation
 - Applicable crowd: special tourniquet for dialysis, with strong adhesion, can be used repeatedly, and can be adjusted freely, fat and thin
- 長度隨意調，經久耐用，寬大柔軟舒服親膚
 - 高彈鬆緊，反復使用不變形
 - 加寬魔术貼，固定性強
 - 適用人群：透析專用止血帶，粘力強反復使用，隨意調節鬆緊，胖瘦都能使用



Specifications

Product Model 產品型號	NDG
Product Material 產品材質	high elasticity and tightness 高彈鬆緊
Color 顏色	black 黑色
Product Size 產品尺寸	35*4cm
Product Weight 產品重量	11g
Package Size 包裝尺寸	10*10*3cm
Packing Weight 包裝重量	0.05kg

Instructions

- ◆ 取出產品，根據自己的需求調節大小，粘上魔术貼即可

注意事項：

- ◆ 請勿使用金屬清潔球等尖銳物品進行清洗；
- ◆ 使用後請及時洗淨晾乾；
- ◆ 請勿長期置於高溫場所，以免變形；
- ◆ 請勿接觸明火及腐蝕性液體。、烘烤，固定腹帶鬆緊要適度。對乳膠過敏者慎用。

Stainless Steel Tweezers

不銹鋼鑷

Model: NDQ

Features:

- Fine workmanship, stable clamping and convenient use
- The whole is round, smooth and delicate, without diamond corner and burr

- 精工細作, 夾持穩固, 使用方便
- 整體圓潤光滑細膩, 無菱角, 無毛刺

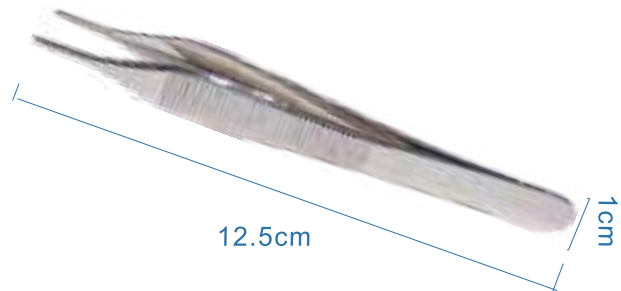

Specifications

Product Model 產品型號	NDQ
Product Material 產品材質	stainless steel 不銹鋼
Product Size 產品尺寸	12.5*1*1.5cm
Product Weight 產品重量	25g
Package Size 包裝尺寸	10*10*3cm
Packing Weight 包裝重量	0.05kg

Instructions

注意事項:

- ◆ 請勿使用金屬清潔球等尖銳物品進行清洗;
- ◆ 使用後請及時洗淨晾乾;
- ◆ 請勿長期置於高溫場所, 以免變形;
- ◆ 請勿接觸明火及腐蝕性液體。

Stainless Steel Straight/curved Scissors

不銹鋼直/彎剪刀

Model: NDR

Features:

- Stainless steel material, thickened steel core, not easy to oxidize
- Double cutting edge, fine grinding and forging, easy to cut
- The finger ring is smooth, circular in shape, not easy to grind
- Polished smooth, the surface is bright and fresh, and the feel is light
- 不銹鋼材質, 加厚鋼芯, 不易氧化
- 雙重開刃, 精細打磨鍛造, 易裁剪
- 指圈圓滑, 做工圓弧, 不易磨手
- 打磨光滑, 表面光新亮麗, 手感輕便



Specifications

Product Model 產品型號	NDR
Product Material 產品材質	stainless steel 不銹鋼
Specifications 規格	straight head and elbow 直頭、彎頭
Product Size 產品尺寸	10.5*4.5cm
Product Weight 產品重量	18g~15g
Package Size 包裝尺寸	10*10*3cm
Packing Weight 包裝重量	0.05kg

Instructions

注意事項:

- ◆ 請勿使用金屬清潔球等尖銳物品進行清洗;
- ◆ 使用後請及時洗淨晾乾;
- ◆ 請勿長期置於高溫場所, 以免變形;
- ◆ 請勿接觸明火及腐蝕性液體。

Stainless Steel Straight/curved Hemostatic Forceps

不銹鋼直/彎止血鉗

Model: NDS

Features:

- Sawtooth design, tight fit, easy to grip, not easy to drop
 - Round grip, comfortable feel, not easy to deform, not easy to grind
 - Flexible joints, smooth opening and closing, good handle
 - Fixed clamping force, lock tooth design, can be used for hemostasis, winding cotton ball and other functions
-
- 鋸齒設計, 緊密貼合, 容易夾取, 不易掉落
 - 圓潤握把, 手感舒適, 不易變形, 不易磨手
 - 靈活關節, 開合順暢, 使用手感好
 - 固定夾力, 鎖齒設計, 可用於止血纏繞棉球等作用



Specifications

Product Model 產品型號	NDS
Product Material 產品材質	stainless steel 不銹鋼
Specifications 規格	straight head and elbow 直頭、彎頭
Product Size 產品尺寸	12.5*6.5cm
Product Weight 產品重量	26g~20g
Package Size 包裝尺寸	12*12*5cm
Packing Weight 包裝重量	0.07kg

Instructions

注意事項:

- ◆ 請勿使用金屬清潔球等尖銳物品進行清洗;
- ◆ 使用後請及時洗淨晾乾;
- ◆ 請勿長期置於高溫場所, 以免變形;
- ◆ 請勿接觸明火及腐蝕性液體。

Independently Packaged Wound Dressings

獨立包裝 傷口貼敷料

Model: NDT

Features:

- Breathable and skin friendly, without shedding hair
- Independent packaging, compact and portable, easy to tear
- Made of high-quality cotton with gauze sheets
- Scope of use: Provided to medical and health institutions for surgery, wound care, and home trauma care, etc
- 透氣親膚、不掉毛
- 獨立包裝, 小巧便攜, 容易撕裂
- 採用優質棉製造, 紗布片
- 使用範圍: 供給醫療衛生單位手術、傷口護理和家庭創傷護理等



Specifications

Product Model 產品型號	NDT
Product Material 產品材質	non-woven fabric+gauze 無紡布+紗布
Specifications 規格	5pcs+5pcs
Warranty Period 質保期	3 years
Product Size 產品尺寸	10*10cm
Product Weight 產品重量	18.5g + 21.5g

Instructions

- ◆ 取出產品, 按需使用即可。

注意事項:

- ◆ 請勿使用金屬清潔球等尖銳物品進行清洗;
- ◆ 使用後請及時洗淨晾乾;
- ◆ 請勿長期置於高溫場所, 以免變形;
- ◆ 請勿接觸明火及腐蝕性液體。

Disposable Iodophor Hand Wash Brush

一次性碘伏洗手刷

Model: NEL

Features:

- Mild disinfection, convenient to use
- Silicone whiskers, soft to the touch, do not harm the skin, are not prone to short whiskers, and are durable and long-lasting
- Even distribution of tactile points, long and soft tendrils, with massage effect
- Used to clean hands and arms before surgery

- 溫和消毒, 使用方便
- 矽膠觸鬚, 手感柔軟, 不傷肌膚, 不易短須, 經久耐用
- 觸覺點分佈均勻, 長柔軟觸鬚, 具有按摩效果
- 用於在手術前清潔手和手臂



Specifications

Product Model 產品型號	NEL
Product Material 產品材質	7.5% povidone iodine, hydroxyethyl cellulose nonylphenol polyoxyethylene ether, purified water 聚維酮碘7.5%、羥乙基纖維素、壬基酚聚氧乙烯醚、純淨水
Warranty Period 質保期	3 years
Product Size 產品尺寸	13*8*3.9cm
Product Weight 產品重量	33g

Instructions

- ◆ 用水弄濕雙手和前臂, 用指甲清潔劑清潔指甲下方, 用浸漬過的刷子擦洗3分鐘, 密切注意指甲、角質層和指間水療。
- ◆ 用自來水徹底沖洗, 重複上述步驟。

注意事項:

- ◆ 僅供外用, 不要用在眼睛裏。
- ◆ 如果皮膚出現刺激、敏感、發紅、疼痛或腫脹的症狀, 停止使用, 請諮詢醫生。
- ◆ 請放在兒童接觸不到的地方, 如果吞食, 立即尋求醫療幫助或聯繫中毒控制中心。
- ◆ 儲存在黑暗的地方, 溫度低於28°C (82.4°F), 一次性使用後丟棄。

Sponge Tracheal Fixation Strap

海棉氣管固定帶

Model: NED

Features:

- Comfortable to wear, made of sponge and a small amount of synthetic fiber, reusable
 - Comfortable fabric, preferred fabric, skin friendly and comfortable
 - Easy to operate, easy to wear, and adjustable at will
 - Free adjustment of elasticity and the ability to cut freely
- 佩戴舒適, 由海棉和少量人造纖維製成, 可重複使用
 - 面料舒適, 優選布料, 親膚舒適
 - 操作便捷, 穿戴方便, 隨意調節
 - 可自由調節鬆緊, 可任意裁剪

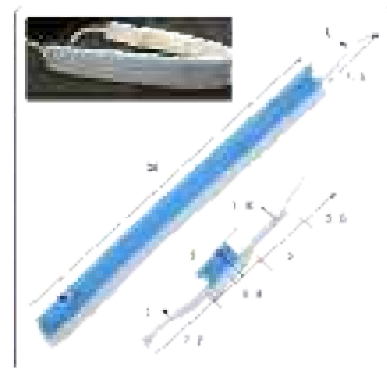

Specifications

Product Model 產品型號	NED
Product Material 產品材質	sponge 海綿
Product Size 產品尺寸	35*2cm
Product Weight 產品重量	4g
Package Size 包裝尺寸	10*10*3cm
Packing Weight 包裝重量	0.02kg

Instructions

- ◆ 取出產品, 根據自己的需求調節大小, 粘上魔術貼即可。

注意事項:

- ◆ 請勿使用金屬清潔球等尖銳物品進行清洗;
- ◆ 使用後請及時洗淨晾乾;
- ◆ 請勿長期置於高溫場所, 以免變形;
- ◆ 請勿接觸明火及腐蝕性液體。

Abdominal Dialysis Tube Protection Belt

腹透管路保護腰帶

Model: NEE

Features:

- Made of woolen cotton material, breathable and durable, and featuring a hollowed out design
- Adjustable at will, ultra-thin design, Velcro allows for adjustable waist belt length
- Super strong elasticity, comfortable width, not cramping the stomach, durable and wear-resistant
- Product function: Abdominal dialysis tube fixation, protecting against dust and bacteria

- 採用呢絨棉材料，透氣耐用，並且採用鏤空設計，透氣效果佳
- 隨意調節，超薄設計，魔术貼可隨意調節腰帶長短
- 超強彈力，寬度舒適，不勒肚子，經久耐用抗磨損
- 產品功能：腹透管固定，保護防塵防菌



Specifications

Product Model 產品型號	NEE
Product Material 產品材質	cotton, cotton fiber, rubber bands 棉、棉綸、橡筋
Applicable Waist Circumference 適用腰圍	70-100cm
Product Size 產品尺寸	100*6cm
Product Weight 產品重量	42g

Instructions

- ◆ 取出產品，根據自己的需求調節大小，粘上魔术貼即可。

注意事項：

- ◆ 請勿使用金屬清潔球等尖銳物品進行清洗；
- ◆ 使用後請及時洗淨晾乾；
- ◆ 請勿長期置於高溫場所，以免變形；
- ◆ 請勿接觸明火及腐蝕性液體。

Adjustable Abdominal Dialysis Care Belt

可調節腹透護理腰帶

Model: NEF

Features:

- Adjustable elasticity, adjustable length, high flexibility
 - Comfortable to wear, made of cotton and a small amount of synthetic fiber, reusable
 - Comfortable fabric, elastic woven tape, preferred fabric, skin friendly and comfortable
 - Easy to operate, easy to wear, and adjustable at will
- 鬆緊可調, 長度可調, 有彈性, 靈活性高
 - 佩戴舒適, 由棉和少量人造纖維製成, 可重複使用
 - 面料舒適, 彈性編織帶, 優選布料, 親膚舒適
 - 操作便捷, 穿戴方便, 隨意調節

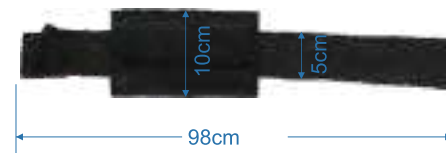

Specifications

Product Model 產品型號	NEF
Product Material 產品材質	cotton, cotton fiber, rubber bands 棉、棉綸、橡筋
Applicable Waist Circumference 適用腰圍	≤115cm
Product Size 產品尺寸	98*5cm
Product Weight 產品重量	41g

Instructions

- ◆ 取出產品, 根據自己的需求調節大小, 粘上魔術貼即可。

注意事項:

- ◆ 請勿使用金屬清潔球等尖銳物品進行清洗;
- ◆ 使用後請及時洗淨晾乾;
- ◆ 請勿長期置於高溫場所, 以免變形;
- ◆ 請勿接觸明火及腐蝕性液體。



Ziglite Smart Health Care Products Co., Ltd.
節亮康護產品有限公司

Hong Kong Office Address

Room B3, 18/F Bonsun Industrial Building, 364-366 Sha Tsui Road, Tsuen Wan, Hong Kong

Office Hour : Mon - Fri : 9:30 - 5:30pm

Email : info@ziglite.com

Office : +852 3107 7500

Fax: +852 3544 0462

Whatsapp : +852 6827 2010



www.ziglite.com

